



# DIGITAL INVERTER GENERATOR



## EG-i-3600LN OPERATOR'S MANUAL

|  |  |
|--|--|
|  <b>WARNING</b> |  |
|                 | Read and understand all provided literature before use. Failure to do so could result in serious injury. |



Read and understand all provided literature before use. Failure to do so could result in serious injury.

MODEL EG-i-3600LN  
SERIAL NUMBER EG-i-200615- A0000001 & UP

This product complies with CAN ICES-2/NMB-2

|   |    |
|---|----|
| <b>Safety</b>                             |    |
| Introduction .....                        | 4  |
| Safety Warnings .....                     | 5  |
| Important Safety Instructions .....       | 9  |
| <b>Description</b>                        |    |
| Breakdown .....                           | 11 |
| Control Panel .....                       | 13 |
| <b>Control Panel Function</b>             |    |
| 3 in 1 switch knob .....                  | 14 |
| Oil warning light (red) .....             | 14 |
| Overload indicator light (red) .....      | 15 |
| AC power indicator (green) .....          | 15 |
| DC protector .....                        | 16 |
| Engine smart control (ESC) .....          | 16 |
| Fuel tank cap .....                       | 17 |
| Ground (Earth) terminal .....             | 17 |
| Air index .....                           | 17 |
| Grounding instructions .....              | 18 |
| <b>Preparation</b>                        |    |
| Fuel .....                                | 19 |
| Engine oil .....                          | 19 |
| Pre-operation check .....                 | 20 |
| <b>Operation</b>                          |    |
| Operation .....                           | 21 |
| Starting the engine .....                 | 22 |
| Stopping the engine .....                 | 23 |
| Alternating Current (AC) connection ..... | 24 |
| Battery Charging .....                    | 24 |
| Application range .....                   | 26 |

**Maintenance**

Maintenance ..... 27

High altitude replacement kit ..... 29

Spark plug inspection ..... 30

Carburetor adjustment ..... 31

Engine oil replacement ..... 31

Air filter ..... 32

Muffler screen and spark arrester ..... 33

Fuel tank filter ..... 34

Fuel filter ..... 34

**Storage**

Drain the fuel ..... 35

Engine ..... 36

**Troubleshooting**

Engine won't start ..... 36

Generator won't produce power ..... 37

Specifications ..... 38

Wiring Diagram ..... 39

**Warranty**

Limited warranty statement ..... 39

CARB and EPA warranty statement ..... 41



**Attention: Read through the complete manual prior to the initial use of your generator.**

### **Using the Operator's manual**

The operator's manual is an important part of your generator. It should be read thoroughly before initial use, and referred to often to make sure adequate safety and service concerns are being addressed.

Reading the owner's manual thoroughly will help avoid any personal injury or damage to your machine. By knowing how best to operate this machine you will be better positioned to show others who may also operate the unit.

This manual contains information for the ECHO Inverter Generator and was written to take you from the safety requirements to the operating functions of your machine. You can refer back to the manual at any time to help troubleshoot any specific operating functions, so store it with the machine at all times.

### **RECORD IDENTIFICATION NUMBERS**

If you need to contact an Authorized Dealer or Customer Service line for information on servicing, always provide the product model and identification numbers.

You will need to locate the model and serial number for the machine and record the information in the places provided below.

|                          |
|--------------------------|
| <b>Date of Purchase:</b> |
| <b>Dealer Name:</b>      |
| <b>Dealer Phone:</b>     |

|                                       |
|---------------------------------------|
| <b>Product Identification Numbers</b> |
| <b>Model Number:</b>                  |
| <b>Serial Number:</b>                 |

To ensure trouble free warranty coverage it is important that you register your ECHO on-line at:  
**<http://www.echo-usa.com/Warranty/Register-Your-ECHO>**

## SAVE THESE INSTRUCTIONS

### SAFETY WARNINGS



This is the safety alert symbol. It is used to alert you to potential personal injury hazards. Obey all safety messages that follow this symbol to avoid possible injury or death.

The safety alert symbol (  ) is used with a signal word (DANGER, CAUTION, WARNING), a pictorial and/or a safety message to alert you to hazards.

The safety alert symbol accompanied by the word “**DANGER**” calls attention to an act or condition which **WILL** lead to serious personal injury or death if not avoided.

The safety alert symbol accompanied by the word “**WARNING**” calls attention to an act or condition which **CAN** lead to serious personal injury or death if not avoided.

The safety alert symbol accompanied by the word “**CAUTION**” calls attention to an act or condition which may lead to minor or moderate personal injury if not avoided.

**NOTICE** indicates a situation that could result in equipment or damage to other property. Ensure all safety measures are observed and adhered to.

### HAZARD SYMBOLS AND MEANINGS



EXPLOSION



FIRE



ELECTRIC SHOCK



TOXIC FUMES



KICKBACK



READ MANUAL

Read and understand this owner's manual before operating your generator. It will help you avoid accidents if you are familiar with your generator's safe operation procedures.

**⚠ WARNING**

Generator exhaust contains carbon monoxide, a poisonous gas that can kill you.

You **CANNOT** smell or see this gas.

- Use the generator outdoors, away from open windows, vents, or doors that could allow the carbon monoxide gas to come indoors. Keep the generator at least 1 meter (3 feet) away from any structure or building during use.
- **NEVER** use a generator indoors, including in homes, garages, basements, crawl spaces, and other enclosed or partially-enclosed areas, even with ventilation. Opening doors and windows or using fans will not prevent carbon monoxide build-up in the home.
- **NEVER** use a generator in enclosed or partially-enclosed spaces. Generators can produce high levels of carbon monoxide very quickly. When you use a portable generator, remember that you cannot smell or see carbon monoxide. Even if you can't smell exhaust fumes, you may still be exposed to carbon monoxide.
- **NEVER** operate the generator in an explosive atmosphere, near combustible materials or where ventilation is not sufficient to carry away exhaust fumes. Exhaust fumes can cause serious injury or death.
- If you start to feel sick, dizzy, or weak while using a generator, get to fresh air **RIGHT AWAY**. **DO NOT DELAY**. The carbon monoxide from generators can rapidly lead to full incapacitation and death.
- If you experience serious symptoms, seek medical attention immediately. Inform medical staff that carbon monoxide poisoning is suspected. If you experienced symptoms while indoors, have someone call the fire department to determine when it is safe to re-enter the building.

**⚠ WARNING**

Fuel and vapors are extremely flammable and explosive.



Fire or explosion can cause severe burns or death.

**WHEN ADDING OR DRAINING FUEL**

- Observe all safety regulations for the safe handling of fuel. Handle fuel in safety containers. If the container does not have a spout, use a funnel.
- Do not overfill the fuel tank, leave room for the fuel to expand.
- Do not refill fuel tank while the engine is running. Before refueling the generator, turn it off and let it cool down. Gasoline spilled on hot engine parts could ignite.
- Fill the tank only on an area of bare ground. While fueling the tank, keep heat, sparks and open flame away. Carefully clean up any spilled fuel before starting engine.
- Always fill fuel tank in an area with plenty of ventilation to avoid inhaling dangerous fumes.
- NEVER store fuel for your generator in the home. Gasoline, propane, kerosene, and other flammable liquids should be stored outside of living areas in properly-labeled, non-glass safety containers. Do not store them near a fuel-burning appliance, such as a natural gas water heater in a garage. If the fuel is spilled or the container is not sealed properly, invisible vapors from the fuel can travel along the ground and can be ignited by the appliance's pilot light or by arcing from electric switches in the appliance.

**WARNING**

ADVERTENCIA • AVERTISSEMENT

Cancer and Reproductive Harm  
 Cáncer y Daño Reproductivo  
 Cancer et dommages à la reproduction

**[www.P65Warnings.ca.gov](http://www.P65Warnings.ca.gov)**

If the generator should malfunction, grounding provides a path of least resistance for electric current to reduce the risk of electric shock.

**DANGER**

Improper grounding can result in a risk of electrocution. Check with a qualified electrician for your local requirements if you are in doubt as to whether the unit is properly grounded.

This generator is equipped with a grounding terminal for added protection. Using the ground path from the generator to an external ground source as instructed in the section labeled "Grounding Instructions" in the CONTROL FUNCTION section of this manual can be necessary. Please consult a qualified electrician for local regulations.

The generator is a potential source of electrical shock if not kept dry. Keep the generator dry and do not use in rain or wet conditions. To protect from moisture, operate it on a dry surface under an open, canopy-like structure. Dry your hands if wet before touching the generator.



Plug appliances directly into the generator. Or, use a heavy duty, outdoor-rated extension cord that is rated (in watts or amps) at least equal to the sum of the connected appliance loads. Check that the entire cord is free of cuts or tears and that the plug has all three prongs, especially a grounding pin.

**NEVER** try to power the house wiring by plugging the generator into a wall outlet, a practice known as "back feeding". This is an extremely dangerous practice that presents an electrocution risk to utility workers and neighbors served by the same utility transformer. It also bypasses some of the built-in household circuit protection devices.

If you must connect the generator to the house wiring to power appliances, have a qualified electrician install the appropriate equipment in accordance with local electrical codes.



**IMPORTANT SAFETY INSTRUCTIONS**

|  <b>WARNING</b> |  |
|--|--|
|                 | <p>To reduce the risk of injury, read this operator's manual completely before using.</p> <p>When using this product, the following basic precautions should always be followed.</p> |

- Do not enclose the generator or cover it. The generator may become overheated if it is enclosed.
- If generator has been covered to protect it from the weather during non use, be sure to remove it and keep it well away from the area during generator use.
- Operate the generator on a level surface. It is not necessary to prepare a special foundation for the generator. However, the generator will vibrate on an irregular surface, so choose a level place.
- If the generator is tilted or moved during operation, fuel may spill and/or the generator may tip over, causing a hazardous situation. Proper lubrication cannot be expected if the generator is operated on a steep incline or slope. In such a case, piston seizure may occur even if the oil is above the upper level.
- Pay attention to the wiring or extension cords from the generator to the connected device. If the wire is under the generator or in contact with vibrating part, it may break and possibly cause a fire, generator burnout, or electric shock hazard. Replace damaged or worn cords immediately.
- Do not operate in rain, in wet or damp conditions, or with wet hands. The operator may suffer severe electric shock if the generator is wet due to rain or snow. If wet, wipe and dry it well before starting. Do not pour water directly over the generator, nor wash it with water.
- Be extremely careful that all necessary electrical grounding procedures are followed during each and every use. Failure to do so can be fatal.
- DO NOT smoke while charging a battery. The battery emits flammable hydrogen gas, which can explode if exposed to electric arcing or open flame. Keep the area well ventilated and keep open flames / sparks away when charging a battery.
- The engine becomes extremely hot during and for some time after operation. Keep combustible materials well away from generator area. Be very careful not to touch any parts of the hot engine

especially the muffler area or serious burns may result.

- Keep children and all bystanders at a safe distance from work area.
- It is absolutely essential that you know the safe and proper use of the power tool or appliance that you intend to use. All operators must read, understand and follow the tool / appliance owners manual. Tool and appliance applications and limitations must be understood. Follow all directions given on labels and warnings. Keep all instruction manuals and literature in a safe place for future reference.
- Use only "LISTED" extension cords. When a tool or appliance is used outdoors, use only extension cords marked "For Outdoor Use" Extension cords, when not in use should be stored in a dry and well ventilated area.
- Always switch off generator's AC circuit breaker and disconnect tools or appliances when not in use, before servicing, adjusting, or installing accessories and attachments.
- Make sure the engine is stopped before starting any maintenance, servicing or repair.

NOTE: Make sure maintenance and repair of the generator are performed by properly trained personnel only.

SAVE THESE INSTRUCTIONS

BREAKDOWN

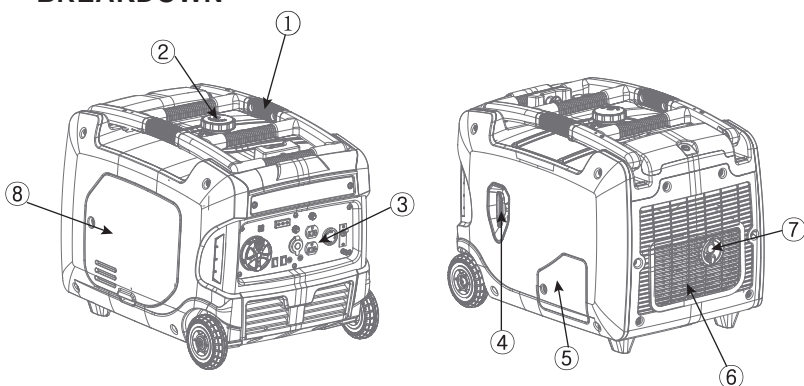

1. Carrying handle
2. Fuel tank cap
3. Control panel
4. Recoil starter
5. Oil filler cap
6. Louver
7. Muffler
8. Spark plug cover

LED FUNCTION DISPLAY (EGI-3600LN)

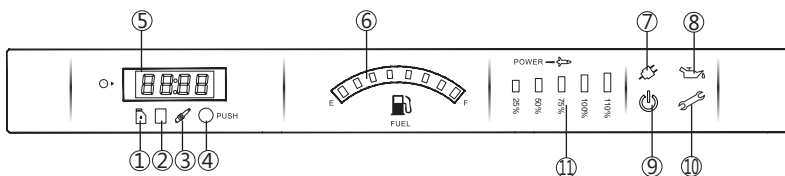

- |  |  |
|--|--|
| <ol style="list-style-type: none"> <li>1. Oil change indicator</li> <li>2. Air cleaner maintenance indicator</li> <li>3. Spark plug maintenance indicator</li> <li>4. Switch button</li> <li>5. Multi functional digital meter</li> <li>6. Fuel level indicator</li> </ol> | <ol style="list-style-type: none"> <li>7. On-load indicator</li> <li>8. Oil alert indicator</li> <li>9. Inverter running indicator</li> <li>10. Inverter alert indicator</li> <li>11. Power display</li> </ol> |
|--|--|

240V

5 - Multi functional digital meter

Voltage-U000, Frequency-F00.0, Total working time-000.0(0.1h) ,  
Working hours at one time-00.00 Switch the display by pushing - 4

1 - Red

Oil change indicator, first time indicate after 50hrs, and then  
indicate once every 100hrs. Every indicating lasts 1hr.

2 - Red

Air cleaner maintenance indicator, indicate once every 100hrs.  
Every indicating lasts 1hr.

3 - Red

Spark plug maintenance indicator,indicate once every 100hrs.  
Every indicating lasts 1hr.

6 - Fuel level indicator

Full-Green, all lights on Low  
fuel level-lights turn orange

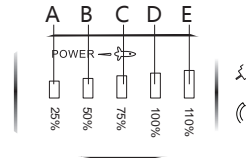

11 - Power display

Power lower than 25%, light A turns green. Power display Power  
lower than 50%, light A&B turns green.

Power lower than 75% light A&B&C turns green.

Power lower than 100%, light A&B&C&D turns green.

Power higher than 100%,but lower than 110%, light A&B&C&D turns  
green&red.

Power higher than 110%, light A&B&C&D&E turns red.

7 - Green On-load indicator light on green while the inverter is on-load.

8 - Red Oil alert light on while the oil is empty

9 - Green Inverter working indicator.

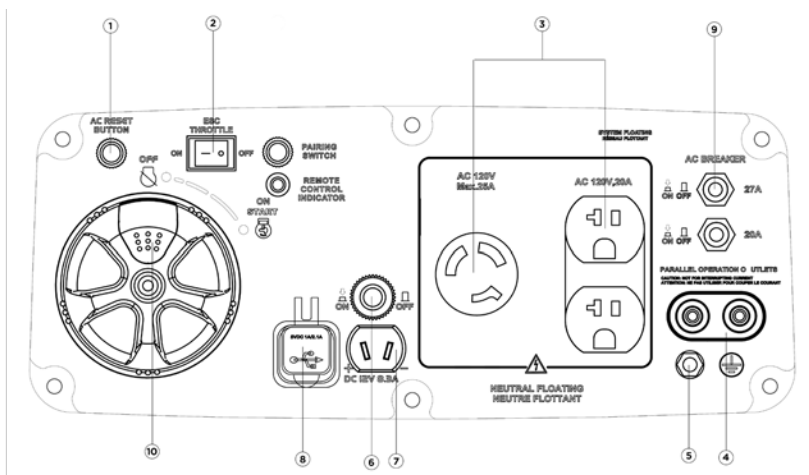

10 - Red Inverter alert indicator. Light is off while this light is constantly on

## CONTROL PANEL

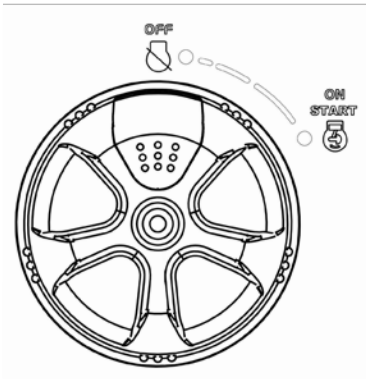

- |                              |                  |
|------------------------------|------------------|
| 1. AC reset                  | 6. USB           |
| 2. ECS(Engine Smart Control) | 7. DC receptacle |
| 3. AC receptacle             | 8. DC Protector  |
| 4. Parallel function         | 9. AC breaker    |
| 5. Ground (earth) terminal   | 10. Switch knob  |

**3 IN 1 SWITCH KNOB**

- (1) Engine switch/fuel valve  "OFF";  
Ignition circuit is switched off. Fuel is switched off.  
The engine will not run.
- (2) Engine switch/fuel valve  "ON";  
Ignition circuit is switched on. Fuel is switched on. Choke is  
switched on. The engine can be started.

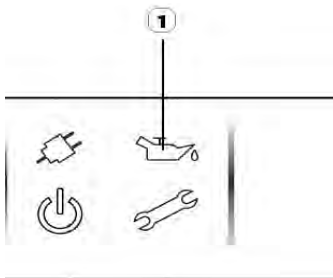
**OIL WARNING LIGHT (RED)**

When the oil level falls below the lower level, the oil warning light (1) comes on and then the engine stops automatically. Unless you change the oil, the engine will not start again.

**TIP:** If the engine stalls or does not start, turn the engine switch to "ON" and then pull the recoil starter. If the oil warning light flickers for a few seconds, the engine oil level is insufficient. Add oil and restart.

## OVERLOAD INDICATOR LIGHT (RED)

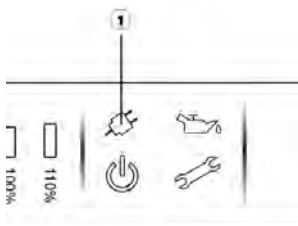

The overload indicator light (1) comes on when an overload of a connected electrical device is detected, the inverter control unit overheats, or the AC output voltage rises. Then, the AC protector will trip, stopping power generation in order to protect the generator and any connected electric devices. The AC pilot light (Green) will go off and the overload indicator light (Red) will stay on, but the engine will not stop running.

When the overload indicator light comes on and power generation stops, proceed as follows:

1. Turn off any connected electric devices and stop the engine.
2. Reduce the total wattage of connected electric devices within the rated output.
3. Check for blockages in the cooling air inlet and around the control unit. If any blockages are found, remove them.
4. After checking, restart the engine.

**TIP:** The overload indicator light may come on for a few seconds at first when using electric devices that require a large starting current, such as a compressor or a submersible pump. This is normal and should not be treated as a malfunction.

## AC POWER INDICATOR (GREEN)

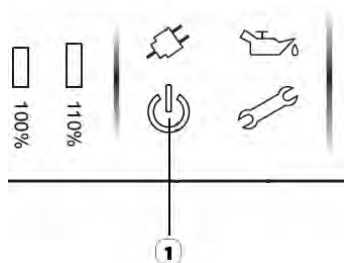

The AC power indicator (1) comes on when the engine starts and produces power.

**DC PROTECTOR**

The DC protector turns to “OFF” (2) automatically when the electric device connected to the generator is operated above rated flow. To use this equipment again, turn on DC protector by pressing its button to “ON” (1)

- (1) “ON”  
Outputting direct current.
- (2) “OFF”  
Not outputting direct current.

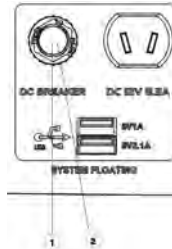
**⚠ CAUTION**

- Reduce the load of the connected electric device below the specified rated output of the generator if the DC protector turns off. If the DC protector turns off again, stop using the device immediately and consult your local dealer.

**ENGINE SMART CONTROL (ESC)**

- (1) “ON”

When the ESC switch is turned to “ON”, the economy control unit controls the engine speed according to the connected load. This results in better fuel economy and reduced noise output.

- (2) “OFF”

When the ESC switch is turned to “OFF”, the engine runs at the rated r/min(4500r/min) regardless of whether a load is connected or not.

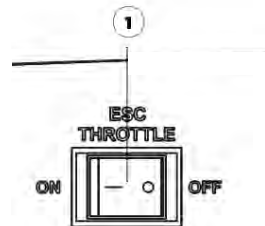

**TIP:** The ESC must be turned to “OFF” when using electric devices that require a large starting current, such as a compressor of a submersible pump.



### FUEL TANK CAP



Remove the fuel tank cap by turning it counterclockwise.

### GROUND (EARTH) TERMINAL

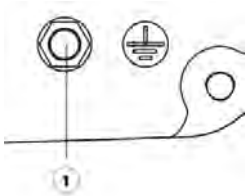



Ground (Earth) terminal (1) connects the earth line for the prevention of an electric shock. All electrical tools and appliances operated from this generator must be properly grounded by use of a third wire or have cords that are "Double Insulated"

### AIR INDEX

An Air Index Information hang tag/label is applied to engines certified to an emission durability time period in accordance with the requirements of the California Air Resources Board.

The bar graph is intended to provide you, our customer, the ability to compare the emissions performance of available engines. The lower the Air Index, the less pollution.

**GROUNDING INSTRUCTIONS**

|  <b>DANGER</b>                                |   |
|--|---|
|   | Improper connection of the equipment grounding conductor can result in a risk of electrocution. |
| Check with a qualified electrician if you are in doubt as to whether the unit is properly grounded for your local regulations. |   |

The ground terminal on the frame can be used to connect the generator to a suitable ground source. The ground path should be made with #8 size wire. Connect the grounding wire securely to the ground terminal. Connect the other end of the wire securely to a suitable ground source.

A metal underground water pipe in direct contact with the earth for at least 10 feet can be used as a grounding source. If a pipe is unavailable, an 8 foot length of pipe or rod may be used as the ground source. The pipe should be 3/4" diameter or larger and the outer surface must be noncorrosive. If a steel or iron rod is used it should be at least 5/8" diameter and if a nonferrous rod is used it should be at least 1/2" diameter and be listed as material for grounding. Drive the rod or pipe to a depth of 8'. If a rock bottom is encountered less than 4 feet down, bury the rod or pipe in a trench. All electrical tools and appliances operated from this generator, must be properly grounded by use of a third wire or be "Double Insulated".

It is recommended to:

1. Use electrical devices with 3 prong power cords.
2. Use an extension cord with a 3 hole receptacle and a 3 prong plug at the opposite ends to ensure continuity of the ground protection from the generator to appliance.

We strongly recommend that all applicable regulations relating to grounding specifications be checked and followed.

FUEL

|   |   |
|---|---|
| <b>⚠ DANGER</b>   |   |
|  | <ul style="list-style-type: none"><li>• Fuel is highly flammable and poisonous. Check “SAFETY INFORMATION” carefully before filling.</li><li>• Do not overfill the fuel tank, otherwise it may overflow when the fuel warms up and expands.</li><li>• After filling, make sure the fuel tank cap is tightened securely.</li></ul> |

**GENERAL RECOMMENDATIONS**

- Purchase gasoline in small quantities and store in clean, approved containers.
- To minimize gum deposits in your fuel system and to insure easy starting, do not use gasoline left over from the previous season.
- Do not add oil to the gasoline.
- Consider adding fuel stabilizer before running or starting the generator.

Recommended fuel: Gasoline with octane rating of 87 or higher  
Fuel tank capacity: 9L, 2.2 GAL

Remove the fuel tank cap and fill the fuel into the tank up to the red level.

(1) Red line

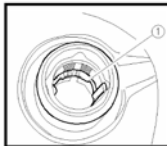

(2) Fuel level

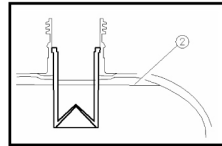

|   |
|---|
| <b>NOTICE</b>   |
| <ul style="list-style-type: none"><li>• Immediately wipe off spilled fuel with a clean and dry cloth. Fuel may deteriorate painted surfaces or plastic parts if left on them.</li><li>• Use only unleaded gasoline. The use of leaded gasoline will cause severe damage to internal engine parts.</li></ul> |

**ENGINE OIL**

Before checking or refilling oil, be sure generator is located on stable and level surface with engine stopped. **This generator uses SAE 10W30 oil.**

1. Turn the oil service knob to “OPEN” and remove the service door.
2. Remove oil dipstick and check the engine oil level.
3. If oil level is below the lower level line, refill with suitable oil to upper level line. Do not screw in the oil dipstick when checking oil level.
4. Change oil if contaminated.

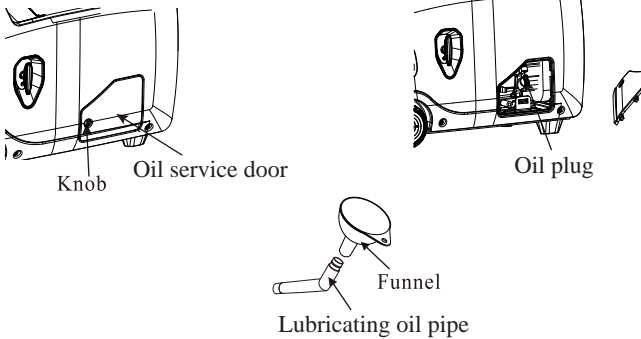

**⚠ NOTICE**



Always check the level of the engine oil prior to starting the generator.

- Failure to do so could cause the engine to seize if the oil is low or empty.

Recommended engine oil:  
SAE SJ 10W-30  
Recommended engine oil grade:  
API Service SE type or higher  
Engine oil quantity: 0.5 L

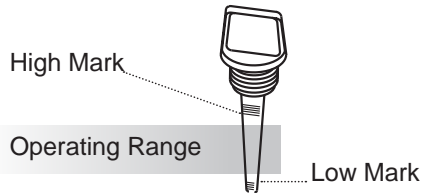

NOTE: Recommended oil may vary due to ambient air temperature. see oil graphic for more information.

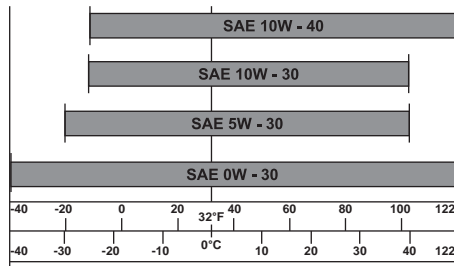

## PRE-OPERATION CHECK

**⚠ WARNING**

- If any item in the Pre-operation check is not working properly, have it inspected and repaired before operating the generator.
- The condition of a generator is the owner's responsibility. Vital components can start to deteriorate quickly and unexpectedly, even if the generator remains unused for a period of time.

**TIP:** Pre-operation checks should be made each time the generator is used.

**Pre-operation check**

**Fuel (See page 19)**

- Check fuel level in fuel tank.
- Refuel if necessary. Be careful not to overfill!

**Engine oil (See page 20)**

- Check oil level and condition in engine.
- If necessary, add recommended oil to specified level or change oil.
- Check generator for oil leakage.

**OPERATION**

|   |
|---|
| <b>WARNING</b>  |
| <ul style="list-style-type: none"><li>• Never operate the engine in a closed area or it may cause unconsciousness and death within a short time. Operate the engine in a well ventilated area.</li><li>• Before starting the engine, do not connect any electric devices.</li></ul>           |
| <b>NOTICE</b>   |
| <ul style="list-style-type: none"><li>• The generator has been shipped without engine oil. Do not start the engine till fill with the sufficient engine oil.</li><li>• Do not tilt the generator when adding engine oil. This could result in overfilling and damage to the engine.</li></ul> |

Operation of this equipment may create sparks that can start fires around dry vegetation. This unit may be equipped with a spark arrester to prevent discharge of hot particles from the engine. The spark arrester may be a standard or an optional part, depending on the engine type. In some areas, it is illegal to operate an engine without a spark arrester. Check local, state, and federal laws and regulations. A spark arrester is available from authorized servicing dealers.

**TIP:** The generator can be used with the rated output load at standard atmospheric conditions.

**Standard Atmospheric Conditions:**

Ambient temperature 25°, Barometric pressure 100kPa

Relative humidity 30%

The output of the generator varies due to changes in temperature, altitude (lower air pressure at higher altitude) and humidity. The output of the generator is reduced when the temperature, humidity, and the altitude are higher than standard atmospheric conditions. Additionally, the load must be reduced when using in a confined area, as generator cooling is affected. We do not recommend using the generator in a confined area, as adequate ventilation must be a priority.

**STARTING THE ENGINE**

1. Turn the ESC switch to "OFF" (1).

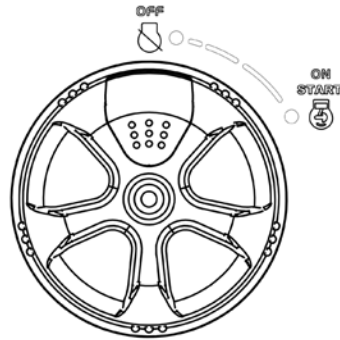
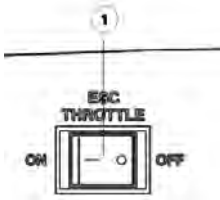

2. Turn the air vent knob to "ON" (2).
3. Turn the 3 in 1 switch to  "CHOKE" (3),
  - a. Ignition circuit is switched on.
  - b. Fuel is switched on.
  - c. Choke is switched on

**TIP:** The choke is not required to start a warm engine. Push the choke knob to the position  "ON".

4. Use electric start or pull slowly on the recoil starter until you feel slight resistance, then pull it briskly.

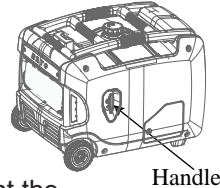

**TIP:** Grasp the carrying handle firmly to prevent the generator from falling over when pulling the recoil starter.

5. After the engine starts, warm up the engine until it doesn't stop when the choke knob is returned to the  "ON" position (4).

|   |
|---|
| <b>⚠ CAUTION</b>  |
| Do not connect appliances with defective power cords and/or plugs.  |
| Be sure appliances are not connected to generator when starting up. Starting the generator with an appliance connected could result in damage to the generator and/or appliances and personal injury. |

**TIP:** When starting the engine, with the ESC "ON", and there is no load on the generator:

- In ambient temperature below 0°C (32°F), the engine will run at the rated r/min (4500r/min) for 5 minutes to warm up the engine.
- In ambient temperature below 5°C (41°F), the engine will run at the rated r/min (4500r/min) for 3 minutes to warm up the engine.
- The ESC unit operates normally after the above time period, while the ESC is "ON".

**NOTICE**

This generator is thoroughly tested and adjusted in the factory. If the generator does not produce the specified voltage, consult your nearest authorized dealer.

1. Turn off the switch(es) of the electrical appliance(s) before connecting to the generator.
2. Insert the plug(s) of the electrical appliance(s) into the receptacle.
  - Be sure that the total wattage of all connected appliances does not exceed the rated output of the generator.
3. Turn on the switch of the appliance.

**STOPPING THE ENGINE**

**TIP:** Turn off any electric devices.

1. Turn the ESC to “OFF” (1).

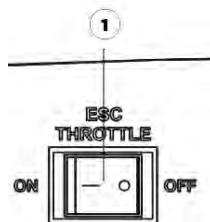

2. Disconnect any electric devices.

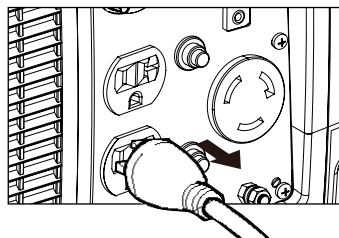

3. Turn the 3 in 1 switch to  “OFF” ,
  - a. Ignition circuit is switched off.
  - b. Fuel is switched off.

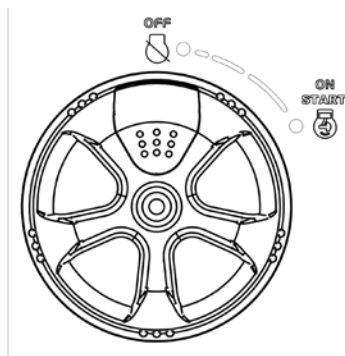

**ALTERNATING CURRENT (AC) CONNECTION****⚠ WARNING**

- Be sure any electric devices are turned off before plugging them in.

**NOTICE**

- Be sure all electric devices including the lines and plug connections are in good condition before connection to the generator.
- Be sure the total load is within the generator's rated output.
- Be sure the receptacle load current is within receptacle rated current.
- The generator (STATOR WINDING) is isolated from the AC receptacle ground pin.
- Electrical devices that require a grounded receptacle pin connection will not function if the receptacle ground pin is not functional.

**TIP:** Make sure to ground the generator. When the electrical device is grounded, the generator must also be grounded.

1. Start the engine.
2. Turn the ESC to "ON".
3. Plug in to AC receptacle.
4. Make sure the AC pilot light is on.
5. Turn on any electric devices.

**TIP:** The ESC must be turned to "OFF" to increase engine speed to rated rpm. If the generator is connected to multiple loads, please remember to connect the one with the highest starting current first and connect the one with the lowest starting current last.

**BATTERY CHARGING****TIP:**

- The generator DC rated voltage is 12V.
- Start the engine first, and then connect the generator to the battery for charging.
- Before starting to charge the battery, make sure that the DC protector is turned on.

1. Start the engine.
2. Connect the red battery charger lead to the positive (+) battery terminal.
3. Connect the black battery charger lead to the negative (-) battery terminal.
4. Turn the ESC "off" to start battery charging.



**NOTICE**

- Be sure the ESC is turned off while charging the battery.
- Be sure to connect the red battery charger lead to the positive (+) battery terminal, and connect the black lead to the negative (-) battery terminal. Do not reverse these positions.
- Connect the battery charger leads to the battery terminals securely so that they are not disconnected due to engine vibration or other disturbances.
- Charge the battery in the correct procedure by following instructions in the owner's manual for the battery.
- The DC protector turns off automatically if current above the rated flows during battery charging. To restart charging the battery, turn the DC protector on by pressing its button to "ON". If the DC protector turns off again, top charge the battery immediately and consult our company authorized dealer.

**TIP:**





- Follow instructions in the owner's manual for the battery to determine the end of battery charging.
- Measure the specific gravity of electrolyte to determine if the battery is fully charged. At full charge, the electrolyte specific gravity is between 1.26 and 1.28.
- It is advisable to check the specific gravity of the electrolyte at least once every hour to prevent overcharging the battery.

 **WARNING**

- Never smoke or make and break connections at the battery while charging. Sparks may ignite the battery gas.
- Battery electrolyte is poisonous and dangerous, causing severe burns, etc. contains sulfuric (sulphuric) acid. Avoid contact with skin, eyes or clothing.
- Antidote:  
**EXTERNAL:** Flush with water.  
**INTERNAL:** Drink large quantities of water or milk. Follow with milk of magnesia, beaten egg or vegetable oil. Call physician immediately.  
**EYES:** Flush with water for 15 minutes and get prompt medical attention.
- Batteries produce explosive gases. Keep sparks, flame, cigarettes, etc., away. Ventilate when charging or using in closed space. Always cover eyes when working near batteries.
- Keep out of reach of children.

**APPLICATION RANGE**

When using the generator, make sure the total load is within rated output. Otherwise, damage to generator may occur.

|                               |   |   |   |   |
|-------------------------------|---|---|---|---|
| AC                            |  |  |  | <small>3kW GENERATOR<br/>                 INVERTER GASOLINE ENGINE GENERATOR<br/>                 Owner's Manual</small><br> |
| Power Factor                  | 1   | 0.8-0.95  | 0.4-0.75<br>(Efficiency 0.85)   |   |
| Rated continuous output power | ≤ 3,000W  | ≤ 2,400W  | ≤ 1,020W  | Rated voltage 12V   |

**TIP:**

- Application wattage indicates when each device is used by itself.
- The simultaneous usage of AC and DC power is possible but total wattage should not exceed the rated output.

**EX:**

|                             |              |                 |
|-----------------------------|--------------|-----------------|
| Generator continuous output |              | 3,000W          |
| Frequency                   | Power factor |                 |
| AC                          | 1.0          | ≤ 3,000W        |
| DC                          | ---          | 100W (12V/8.3A) |

The overload indicator (1) comes on when total wattage exceeds the application range. (See page 11 for more details)

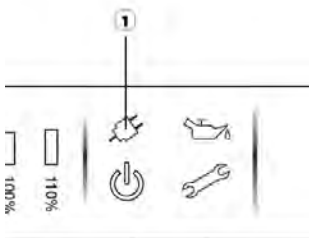

**NOTICE**

- Do not overload. The total load of all electrical appliances must not exceed the supply range of the generator. Overloading will damage the generator.
- When supplying precision equipment, electronic controllers, PCs, Electronic computers, microcomputer based equipment or battery chargers, keep the generator a sufficient distance away to prevent electrical interference from the engine. Also ensure that electrical noise from the engine does not interfere with any other electrical devices located near the generator.
- If the generator is to supply power to medical equipment, advice should first be obtained from the manufacturer or a medical professional.
- Some electrical appliances or general-purpose electric motors have high starting currents, and cannot therefore be used, even if they lie within the supply ranges given in the above table. Consult the equipment manufacturer for further advice.

The engine must be properly maintained to ensure its operation is safe, economical, and free of issues.

Maintenance, replacement, or repair of emission control devices and systems may be performed by any engine repair establishment or individual, using parts that are “certified” to EPA standards.

In order to keep your gasoline engine in good working condition, it must be periodically serviced. The following maintenance schedule and routine inspection procedures must be carefully followed:

| Items                            | Frequency       | Each time | First month or first 20hrs of operation | Thereafter, every 3 months or every 50hrs of operation | Every year or every 100hrs of operation |
|----------------------------------|-----------------|-----------|---|--|---|
| Engine oil                       | Check-Refill    | X         |   |  |   |
|                                  | Replace         |           | X                                       | X  |   |
| Reduction gear oil (if equipped) | Oil level check | X         |   |  |   |
|                                  | Replace         |           | X                                       | X  |   |

|   |                  |                                     |   |   |   |
|---|------------------|-------------------------------------|---|---|---|
| Air filter element  | Check            | X                                   |   |   |   |
|   | Clean            |                                     | X |   |   |
|   | Replace          |                                     |   | X |   |
| Deposit Cup (if equipped)   | Clean            |                                     |   |   | X |
| Spark Plug  | Check and Adjust |                                     |   |   | X |
|   | Replace          | Every year or 250hrs of operation   |   |   |   |
| Spark arrester  | Clean            |                                     |   | X |   |
| Idling (if equipped)*   | Check-adjust     |                                     |   |   | X |
| Valve clearance*  | Check-adjust     |                                     |   |   | X |
| Fuel tank & fuel filter*  | Clean            |                                     |   |   | X |
| Fuel line   | Check            | Every 2 years (change if necessary) |   |   |   |
| Cylinder head, piston   | Clean up carbon* | Every 250hrs                        |   |   |   |
| * These items should be maintained and repaired by an authorized dealer unless the owner has appropriate tools and is proficient with mechanical maintenance. |                  |                                     |   |   |   |

### NOTICE

- If the gasoline engine frequently works under high temperature or heavy load, change the oil every 25 hours.
- If the engine frequently work under dusty or other severe circumstances, clean the air filter element every 10 hours; If necessary, change the air filter element every 25 hours.
- The maintenance period and the exact time (hour), the one which comes first should govern.
- If you have missed the scheduled time to maintain your engine, do it as soon as possible.



### WARNING

- Stop the engine before servicing. Put the engine on a level surface and remove the spark plug cap to prevent the engine from starting.
- Do not operate the engine in a poorly ventilated room or other enclosed area. Be sure to keep good ventilation in working area. The exhaust from the engine may contain poisonous CO, inhalation can cause shock, unconsciousness and even death.

**HIGH ALTITUDE REPLACEMENT KIT FOR EPAIII ENGINES  
3000ft to 6000ft or 6000ft to 8000ft of elevation**

- At high altitude, the standard carburetor air-fuel mixture will be too rich. Performance will decrease and fuel consumption will increase. A very rich mixture will also foul the spark plug and cause hard starting. Operation at an altitude that differs from that at which this engine was certified, for extended periods of time, may increase emissions.
- The fuel system on this Engine or Equipment may be influenced by operation at higher altitudes. Proper operation can be ensured by installing an altitude kit when required. See the table below to determine when an altitude kit is required. Operating this generator without the proper altitude kit installed may increase the engine's emissions and decrease fuel economy and performance. Kits may be obtained from any Dealer, and should be installed by a qualified individual.

| Equipment model* | Fuel     | Altitude Range** | Kit Part Number |
|------------------|----------|------------------|-----------------|
|                  | Gasoline | 0 – 3000 ft      | Not Required    |
|                  |          | 3000 – 6000 ft   | Altitude kit 1# |
|                  |          | 6000 – 8000 ft   | Altitude kit 2# |

- \* Engine, Generator Set, Pressure Washer, Walk-Behind Lawnmower, Compressor, Pump, Tiller etc.
- \*\* Elevation above sea level.
- \* This high altitude jet is to be used at elevations above 3000 feet.
- \* At elevations above 8000 feet, the engine may experience decreased performance, even with the high altitude kit.

If a carburetor is replaced, the proper high altitude kit jet will need to be installed into the replacement carburetor.

|  |
|--|
| <b> WARNING</b>  |
| To prevent serious injury from fire: Follow the kit procedures in a well-ventilated area away from ignition sources. If the engine is hot from use, shut the engine off and wait for it to cool before proceeding. |

|   |
|---|
| <b>NOTICE</b>   |
| The warranty may be void if necessary adjustments are not made for high altitude use. |

## SPARK PLUG INSPECTION

The spark plug is an important engine component which should be checked periodically.

1. Remove the cover (1) and the spark plug cap (2). Insert the tool through the hole from the outside of the cover.

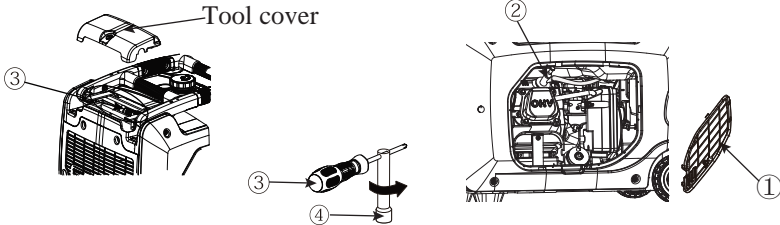

2. Insert the handle (3) into the tool (4) and turn it counterclockwise to remove the spark plug.
3. Check for discoloration and remove the carbon. The porcelain insulator around the center electrode of spark plug should be a medium-to-light tan color.
4. Check the spark plug type and gap.

Spark Plug:  
TORCH F6RTC/F6TC  
Spark Plug Gap: 0.6-0.8mm(0.024-0.03in)

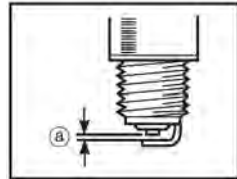

**TIP:** The spark plug gap should be measured with a wire thickness gauge and, if necessary, adjusted to specification.

5. Install the spark plug.

Spark Plug Torque: 28 N\*m (1.25 kgf\*m, 9 lbf\*ft)

**TIP:** If a torque wrench is not available when installing a spark plug, a good estimate of the correct torque is 1/4-1/2 turn past finger tight. However, the spark plug should be tightened to the specified torque as soon as possible.

6. Reinstall the spark plug cap and spark plug cover.

### **CARBURETOR ADJUSTMENT**

The carburetor is a vital part of the engine. Adjusting should be left to our company authorized dealer with the professional knowledge and equipment to do so properly.

### **ENGINE OIL REPLACEMENT**

**⚠ WARNING**

- Avoid draining the engine oil immediately after stopping the engine. The oil is hot and should be handled with care to avoid burns.

Avoid draining the engine oil immediately after stopping the engine. The oil is hot and should be handled with care to avoid burns.

1. Place the generator on a level surface and warm up the engine for several minutes. Stop the engine by turning the switch to "OFF".
2. Remove the screws on the cover and then remove the cover.
3. Place an oil pan under the engine
4. Remove the oil fill cap and the oil drain bolt. Let oil drain completely.
5. Reinstall the oil drain bolt.
6. Add engine oil to the upper level. Reinstall the oil fill cap.
7. Wipe the cover clean, and wipe up any spilled oil.
8. Install the oil filler cap.
9. Install the cover and tighten the screws.

Recommended engine oil: SAE 10W30  
Recommended engine oil grade: API Service SE type or higher  
Engine oil quantity: 0.5L

**NOTE:** Recommended oil may vary due to ambient air temperature. see oil graphic for more information.

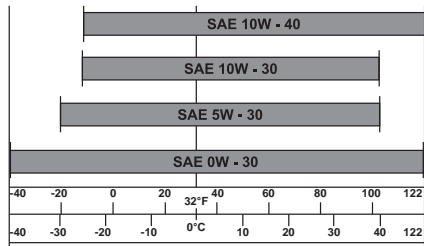

**NOTICE**

- Do not tilt the generator when adding engine oil. This could result in overfilling and damage to the engine.

**NOTICE**

- Be sure no foreign material enters the crankcase.

**AIR FILTER**

1. Remove the screws (1), and then remove the cover (2).
2. Remove the screw (3) and then remove the air filter case cover (4).

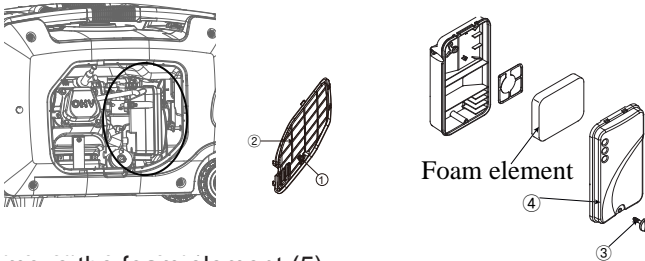

3. Remove the foam element (5).
4. Wash the foam element in solvent and dry it.
5. Soak the foam element in oil and squeeze it to remove any excess. The foam should be wet but not dripping.

Foam element

**NOTICE**

- Do not wring out the foam element when squeezing it. This could cause it to tear.

6. Insert the foam element into the air filter case.

**TIP:** Be sure the foam element sealing surface matches the air filter so there is no air leak.



**The engine should never run without the foam element; excessive piston and cylinder wear may result.**

7. Install the air filter case cover in its original position and tighten the screw.
8. Install the cover and tighten the screws.

**MUFFLER SCREEN AND SPARK ARRESTER**

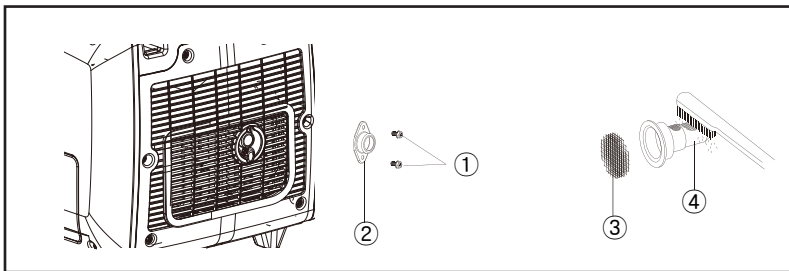

1. Remove the screws (1).
2. Remove the muffler cap (2), the muffler screen (3) and the spark arrester (4).
3. Clean the carbon deposits on the silencer screen and the spark arrester with a wire brush.
4. Check the muffler screen and the spark arrester. Replace if damaged.
5. Reinstall the spark arrester.

The spark arrester may be standard or an optional part, depending on the engine type. In some areas, it is illegal to operate an engine without a spark arrester. Check local, state, and federal laws and regulations. A spark arrester is available from authorized servicing dealers.

**FUEL TANK FILTER****⚠ WARNING**

- Never use the gasoline while smoking or in the vicinity of an open flame.

1. Remove the fuel tank cap and filter.
2. Clean the filter.
3. Wipe the filter dry and reinstall it.
4. Install the fuel tank cap.

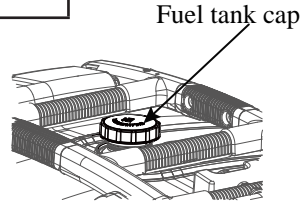

**Be sure the fuel tank cap is tightened securely.**

**FUEL FILTER**

1. Remove the screws (1), and then remove the cover (2), and drain the fuel.

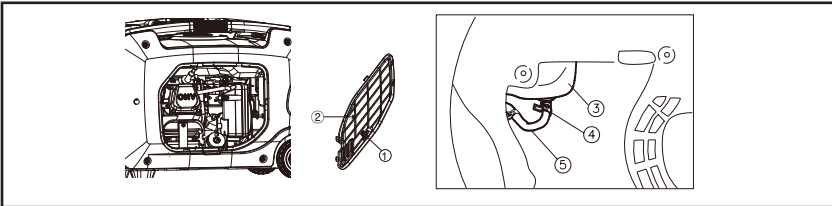

2. Hold and move up the clamp (4), then take off the hose (5) from the tank.
3. Take out the fuel filter.
4. Clean the filter.
5. Dry the filter and put it back into tank.
6. Install the hose and clamp, then open the fuel valve to check for leaks.
7. Install the cover and tighten the screws.

Long term storage of your machine will require some preventive procedures to guard against deterioration.

### DRAIN THE FUEL

1. Turn the 3 in 1 switch to “OFF” (1) .

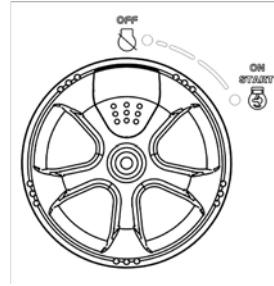

2. Remove the fuel tank cap and then remove the filter. Extract the fuel from the fuel tank into an approved gasoline container. Then, reinstall the fuel tank cap.

#### **WARNING**

- Fuel is highly flammable and poisonous. Check “SAFETY INFORMATION” (page 6) carefully.

#### **NOTICE**

- Immediately wipe off spilled fuel with a clean, dry, and soft cloth as fuel may deteriorate painted surfaces or plastic parts.

3. Start the engine (See Page 19) and leave it running until it stops.  
The engine stops in approx. 20 minutes by running out of fuel.

**TIP:** Do not connect any electrical devices. (unloaded operation)  
Duration of the running engine depends on the amount of the fuel left in the tank.

4. Remove the screws, and then remove the cover.
5. Drain the fuel from the carburetor by loosening the drain screw on the carburetor float chamber.
6. Turn the 3 in 1 switch to “OFF”.
7. Tighten the drain screw.
8. Install the cover and tighten the screws.

## Engine

Perform the following steps to protect the cylinder, piston ring, etc. from corrosion.

1. Remove the spark plug, pour about one tablespoon of SAE 10W-30 into the spark plug hole and reinstall the spark plug. Recoil start the engine by turning over several times (with 4 in 1 switch knob off) to coat the cylinder walls with oil.
2. Pull the recoil starter until you feel compression, then stop pulling. (This prevents the cylinder and valves from rusting).
3. Clean exterior of the generator. Store the generator in a dry, well-ventilated place, with the cover placed over it (cover sold separately).

## TROUBLESHOOTING

### ENGINE WON'T START

#### 1. Fuel systems

No fuel supplied to combustion chamber.

- No fuel in tank...Supply fuel.
- Fuel in tank....Fuel tank cap and fuel knob to "ON"
- Clogged fuel filter .... Clean fuel filter.
- Clogged carburetor.... Clean carburetor.

#### 2. Engine oil system Insufficient

- Oil level is low.... Add engine oil.

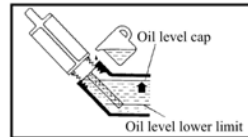

#### 3. Electrical systems

- Put the 3 in 1 switch to "on" and pull the recoil starter ... Poor spark.
- Spark plug dirty with carbon or wet ... Remove carbon or wipe spark plug dry.
- Faulty ignition system ... consult our company authorized dealer.

**GENERATOR WON'T PRODUCE POWER**

- Safety device (DC protector) to “OFF”, Press the DC protector to “ON”.
- The AC pilot light (Green) goes off .... Stop the engine, then restart.

**SPECIFICATIONS**

| <b>MODEL NUMBER</b>      |                                | <b>EGi-3600LN</b>  |
|--------------------------|--------------------------------|--|
| Generator                | Type                           | Silent inverter  |
|                          | Rated frequency (Hz)           | 50   |
|                          | Rated voltage (V)              | 240  |
|                          | Rated output power (kW)        | 1  |
|                          | Power factor                   | 3.0  |
|                          | AC output quality              | ISO8528 G2   |
|                          | Charging voltage (DC) (V)      | 12   |
|                          | Charging current (DC) (A)      | 8.3  |
|                          | Overload protect (DC)          | Non-fuse protector                                       |
| Engine                   | Engine                         | R210-i   |
|                          | Engine type                    | Single cylinder,<br>4-Stroke, forced air<br>cooling, OHV |
|                          | Displacement (cc)              | 212  |
|                          | Fuel type                      | Unleaded gasoline  |
|                          | Fuel tank capacity (L)         | 9.0  |
|                          | Oil capacity (L)               | 0.6  |
|                          | Spark plug model No.           | F6RTC  |
|                          | Valve clearance intake/exhaust | 0.05 ~ 0.10  |
|                          | Starting mode                  | Recoil   Electric  |
| Generator set            | Length×Width×Height (mm)       | 643×480×498  |
|                          | Net weight (kg)                | 46   |
| Spark Arrester Equipped* |                                | Yes  |

\* If a spark arrester is required it must meet the specifications and performance requirements of local, state, and federal laws and regulations. A spark arrester is available from authorized servicing dealers.

## WIRING DIAGRAM

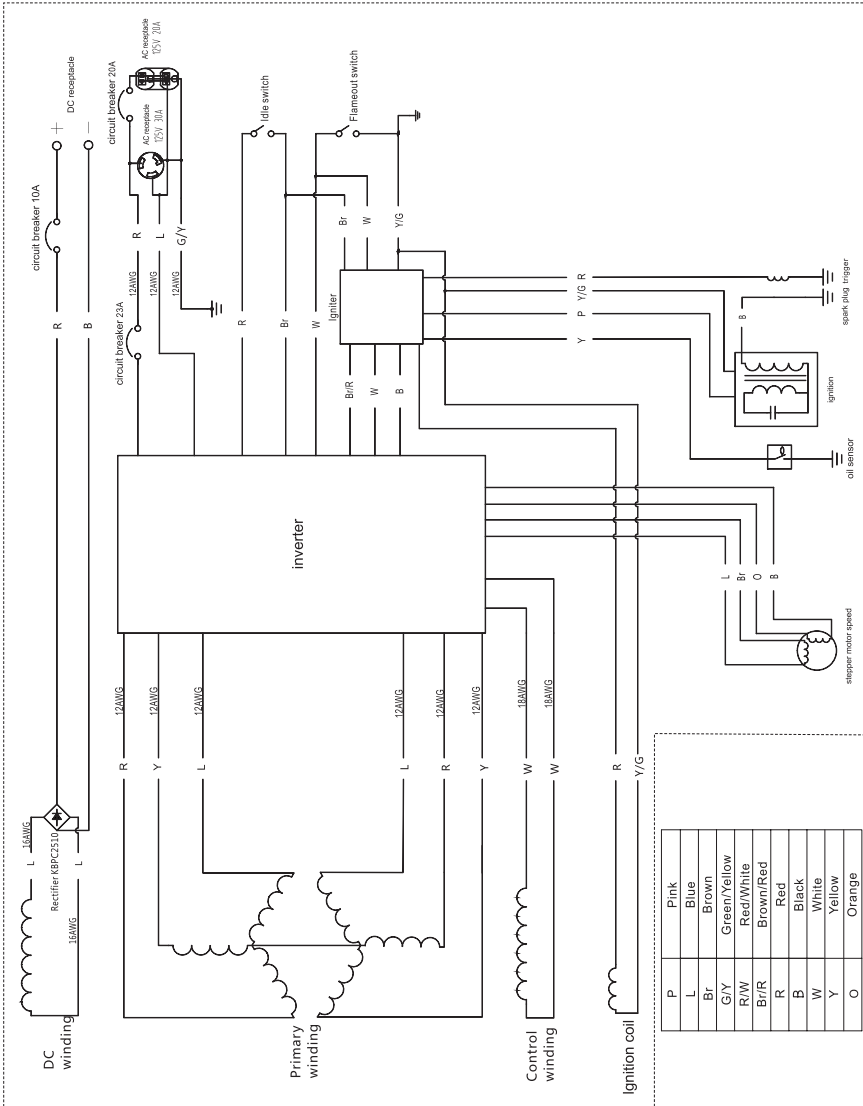

## LIMITED WARRANTY STATEMENT

ECHO Incorporated warrants to the original retail purchaser that this ECHO® brand outdoor product is free from defects in material and workmanship and agrees to repair or replace at ECHO Incorporated's discretion, any defective product free of charge within these time periods from the date of purchase.

- 3 Year Consumer
- 90 Days Commercial
- 90 Days – For Rental Use
- 90 Days Accessories and Replacement Parts

This warranty extends to the original retail purchaser only and commences on the date of the original retail purchase.

Any part of this product found, in the reasonable judgment of ECHO Incorporated, to be defective in material or workmanship will be repaired or replaced without charge for parts and labor by an authorized ECHO dealer. Repair parts and accessories replaced under this warranty are warranted only for the balance of the original warranty period.

The product, including any defective part, must be returned to an authorized ECHO dealer within the warranty period. The expense of delivering the product to the dealer for warranty work and the expense of returning it back to the owner after repair or replacement will be paid by the owner. ECHO Incorporated's responsibility in respect to claims is limited to making the required repairs or replacements and no claim of breach of warranty shall be cause for cancellation or rescission of the contract of sale of any ECHO brand outdoor product. Proof of purchase will be required by the dealer to substantiate any warranty claim. All warranty work must be performed by an authorized ECHO dealer.

This warranty does not cover any product that has been subject to misuse, neglect, negligence, or accident, or that has been operated in any way contrary to the operating instructions as specified in this Operator's Manual. This warranty does not apply to any damage to the product that is the result of improper maintenance or to any product that has been altered or modified. The warranty does not extend to repairs made necessary by normal wear or by the use of parts or accessories which are either incompatible with the ECHO brand outdoor product, or that adversely affect its operation, performance, or durability. In addition, this warranty does not cover wear to normal items such as, but not limited to:

- A. Tune-ups – Air filters, gas filters, carburetors, spark plugs, filters, oil changes
- B. Wear items – Recoil Starter Rope, Motor Brushes, Alternator Brushes, Cotter Pins, Wheels
- C. **IMPORTANT: Some components not covered under this warranty may still be covered by a separate warranty issued by the engine**

**manufacturer. Please see the Engine Manufacturer Warranty (if any) supplied with this product for further details.**

ECHO Incorporated reserves the right to change or improve the design of this product without assuming any obligation to modify any product previously manufactured.

ALL IMPLIED WARRANTIES ARE LIMITED IN DURATION TO THE STATED WARRANTY PERIOD. ACCORDINGLY, ANY SUCH IMPLIED WARRANTIES INCLUDING MERCHANTABILITY, FITNESS FOR A PARTICULAR PURPOSE, OR OTHERWISE, ARE DISCLAIMED IN THEIR ENTIRETY AFTER THE EXPIRATION OF THE APPROPRIATE THREE-YEAR OR 90 DAY WARRANTY PERIOD. ECHO INCORPORATED'S OBLIGATION UNDER THIS WARRANTY IS STRICTLY AND EXCLUSIVELY LIMITED TO THE REPAIR OR REPLACEMENT OF DEFECTIVE PARTS AND ECHO INCORPORATED DOES NOT ASSUME OR AUTHORIZE ANYONE TO ASSUME FOR THEM ANY OTHER OBLIGATION. SOME STATES DO NOT ALLOW LIMITATIONS ON HOW LONG AN IMPLIED WARRANTY LASTS, SO THE ABOVE LIMITATION MAY NOT APPLY TO YOU. ECHO INCORPORATED ASSUMES NO RESPONSIBILITY FOR INCIDENTAL, CONSEQUENTIAL, OR OTHER DAMAGES INCLUDING, BUT NOT LIMITED TO, EXPENSE OF RETURNING THE PRODUCT TO AN AUTHORIZED DEALER FOR ECHO BRAND OUTDOOR PRODUCTS AND EXPENSE OF DELIVERING IT BACK TO THE OWNER, MECHANIC'S TRAVEL TIME, TELEPHONE OR TELEGRAM CHARGES, RENTAL OF A LIKE PRODUCT DURING THE TIME WARRANTY SERVICE IS BEING PERFORMED, TRAVEL, LOSS OR DAMAGE TO PERSONAL PROPERTY, LOSS OF REVENUE, LOSS OF USE OF THE PRODUCT, LOSS OF TIME, OR INCONVENIENCE. SOME STATES DO NOT ALLOW THE EXCLUSION OR LIMITATION OF INCIDENTAL OR CONSEQUENTIAL DAMAGES, SO THE ABOVE LIMITATION OR EXCLUSION MAY NOT APPLY TO YOU.

This warranty gives you specific legal rights, and you may also have other rights which vary from state to state.

This warranty applies to ECHO brand Generators manufactured by or for ECHO Incorporated and sold in the United States and Canada.

To locate your nearest authorized ECHO dealer, visit [www.echo-usa.com](http://www.echo-usa.com) or dial 1-800-432-ECHO (3246).

ECHO Incorporated  
400 Oakwood Rd. Lake Zurich, IL 60047  
1-800-432-ECHO (3246)  
[www.echo-usa.com](http://www.echo-usa.com)



**CALIFORNIA AND FEDERAL EXHAUST AND EVAPORATIVE  
EMISSIONS CONTROL WARRANTY STATEMENT****YOUR WARRANTY RIGHTS AND OBLIGATIONS**

The California Air Resources Board, the United States Environmental Protection Agency and Chongqing Rato Technology Co., Ltd. (Rato), are pleased to explain the exhaust and evaporative emissions (“emissions”) control system warranty on your 2019/2020 small off-road engine/equipment.

In California, new equipment that use small off-road engines must be designed, built, and equipped to meet the State’s stringent anti-smog standards. Rato must warrant the emissions control system on your small off-road engine/equipment for the period listed below provided there has been no abuse, neglect or improper maintenance of your small off-road engine/equipment leading to the failure of the emissions control system.

Your emissions control system may include parts such as the carburetor or fuel-injection system, the ignition system, catalytic converter, fuel tanks, fuel lines (for liquid fuel and fuel vapors), fuel caps, valves, canisters, filters, clamps and other associated components. Also included may be hoses, belts, connectors, and other emission-related assemblies.

Where a warrantable condition exists, Rato will repair your small off-road engine/equipment at no cost to you including diagnosis, parts and labor.

**MANUFACTURER’S WARRANTY COVERAGE**

The exhaust and evaporative emissions control system on your small off-road engine/equipment is warranted for two years. If any emissions-related part on your small off-road engine/equipment is defective, the part will be repaired or replaced by Rato.

**OWNER’S WARRANTY RESPONSIBILITIES**

As the small off-road engine/equipment owner, you are responsible for performance of the required maintenance listed in your owner’s manual. Rato recommends that you retain all receipts covering



maintenance on your small off-road engine/equipment, but Rato cannot deny warranty coverage solely for the lack of receipts or for your failure to ensure the performance of all scheduled maintenance. As the small off-road engine/equipment owner, you should however be aware that Rato may deny your warranty coverage if your small off-road engine/equipment or a part has failed due to abuse, neglect, or improper maintenance or unapproved modifications.

You are responsible for presenting your small off-road engine/equipment to a Rato distribution center or service center as soon as the problem exists. The warranty repairs shall be completed in a reasonable amount of time, not to exceed 30 days.

If you have questions regarding your warranty coverage, you can email us at [echo-usa.custhelp.com/app/ask](mailto:echo-usa.custhelp.com/app/ask) or contact ECHO Incorporated at 1-800-432-ECHO (3246), web site information is available at [WWW.ECHO-USA.COM](http://WWW.ECHO-USA.COM).

## **DEFECTS WARRANTY REQUIREMENTS**

- A. The warranty period begins on the date the small off-road engine/equipment is delivered to an ultimate purchaser.
- B. General Emissions Warranty Coverage. Rato warrants to the ultimate purchaser and each subsequent owner that the engine or equipment is: Designed, built, and equipped so as to conform with all applicable regulations adopted by the Air Resources Board; and Free from defects in materials and workmanship that causes the failure of a warranted part for a period of two years.
- C. The warranty on emission-related parts will be interpreted as follows:
  1. Any warranted part that is not scheduled for replacement as required maintenance in the written instructions must be warranted for the warranty period defined in Subsection (b)(2). If any such part fails during the period of warranty coverage, it must be repaired or replaced by Rato according to Subsection (4) below. Any such part repaired or replaced under the warranty must be warranted for the remaining warranty period.
  2. Any warranted part that is scheduled only for regular inspection in the written instructions must be warranted for the warranty period defined in Subsection (b)(2). A statement in such written instructions to the effect of "repair or replace as necessary" shall

advise owners of the warranty coverage for emissions related parts. Replacement within the warranty period is covered by the warranty and will not reduce the period of warranty coverage. Any such part repaired or replaced under warranty must be warranted for the remaining warranty period.

3. Any warranted part that is scheduled for replacement as required maintenance in the written instructions must be warranted for the period of time prior to the first scheduled replacement point for that part. If the part fails prior to the first scheduled replacement, the part must be repaired or replaced by Rato according to Subsection (4) below. Any such part repaired or replaced under warranty must be warranted for the remainder of the period prior to the first scheduled replacement point for the part.
4. Repair or replacement of any warranted part under the warranty provisions must be performed at no charge to the owner at a warranty station.
5. Notwithstanding the provisions of Subsection (4) above, warranty services or repairs must be provided at distribution centers that are franchised to service the subject engine/equipment.
6. The owner must not be charged for diagnostic labor that leads to the determination that a warranted part is in fact defective, provided that such diagnostic work is performed at a warranty station.
7. Rato is liable for damages to other engine/equipment components proximately caused by a failure under warranty of any warranted part.
8. Throughout the emissions control system's warranty period set out in subsection (b)(2), Rato must maintain a supply of warranted parts sufficient to meet the expected demand for such parts and must obtain additional parts if that supply is exhausted.
9. Manufacturer-approved replacement parts that do not increase the exhaust or evaporative emissions of the engine or emissions control system must be used in the performance of any warranty maintenance or repairs and must be provided without charge to the owner. Such use will not reduce the warranty obligations of Rato.
10. Add-on or modified parts that are not exempted by the Air Resources Board may not be used. The use of any non-exempted add-on or modified parts will be grounds for disallowing a warranty claim. Rato will not be liable to warrant failures of warranted parts caused by the use of a non-exempted add-on or modified part.
11. Rato issuing the warranty shall provide any documents that

describe that warranty procedures or policies within five working days of request by the Executive Officer.

#### D - Emission Warranty Parts List for Exhaust

1. Fuel Metering System
  - Carburetor and internal parts (and/or pressure regulator or fuel injection system).
  - Air/fuel ratio feedback and control system.
  - Cold start enrichment system.
2. Air Induction System
  - Controlled hot air intake system.
  - Intake manifold.
  - Air filter.
3. Ignition System
  - Spark Plugs.
  - Magneto or electronic ignition system.
  - Spark advance/retard system.
4. Exhaust Gas Recirculation (EGR) System
  - EGR valve body, and carburetor spacer if applicable.
  - EGR rate feedback and control system.
5. Air Injection System
  - Air pump or pulse valve.
  - Valves affecting distribution of flow.
  - Distribution manifold.
6. Catalyst or Thermal Reactor System
  - Catalytic converter.
  - Thermal reactor.
  - Exhaust manifold.
7. Particulate Controls
  - Traps, filters, precipitators, and any other device used to capture particulate emissions.
8. Miscellaneous Items Used in Above Systems
  - Electronic controls.
  - Vacuum, temperature, and time sensitive valves and switches.
  - Hoses, belts, connectors, and assemblies.

#### E - Emission Warranty Parts List for Evap

1. Fuel Tank
2. Fuel Cap
3. Fuel Lines (for liquid fuel and fuel vapors)

4. Fuel Line Fittings
5. Clamps\*
6. Pressure Relief Valves\*
7. Control Valves\*
8. Control Solenoids\*
9. Electronic Controls\*
10. Vacuum Control Diaphragms\*
11. Control Cables\*
12. Control Linkages\*
13. Purge Valves\*
14. Gaskets\*
15. Liquid/Vapor Separator
16. Carbon Canister
17. Canister Mounting Brackets
18. Carburetor Purge Port Connector

\*Note: As they relate to the evaporative emission control system.

Rato will furnish with each new small off-road engine/equipment written instructions for the maintenance and use of the engine/equipment by the owner.



**IF YOU NEED ASSISTANCE WITH THE ASSEMBLY OR OPERATION  
OF THIS GENERATOR, PLEASE CONTACT US AT:**

ECHO Incorporated  
400 Oakwood Road  
Lake Zurich, IL 60047  
1-800-432-3246

[www.echo-usa.com](http://www.echo-usa.com)

E-mail: [echo-usa.custhelp.com/app/ask](mailto:echo-usa.custhelp.com/app/ask)