



PW-3100



PW-4200

PRESSURE WASHER OPERATOR'S MANUAL

MODEL PW-3100
SERIAL NUMBER PW-190625-0000001 & UP

MODEL PW-4200
SERIAL NUMBER PW-190626-0000001 & UP

Introduction

Using the Operator's Manual	4
Product Identification	4
PRESSURE WASHER.....	4

Safety

Safety Rules.....	5
Cooling Information.....	6
Hazard Symbols and Meanings.....	7

Assembly

Unpack the Pressure Washer	13
Attach Handle	13

Pressure Washer Components

Component Charts.....	14
-----------------------	----

Pre-Operation Checklist

Follow the Checklist Below	16
Connect Hose and Water Supply to Pump	16

Starting Your Washer

How to Start your Pressure Washer	17
---	----

Shutting Down Your Washer

How to Shut Down your Pressure Washer	21
---	----



Spray Tips

How to Use Spray Tips 22
Change Spray Tips 22
Usage Tips 22

Using Black Soap Nozzle

Applying Detergent 23

Troubleshooting

Gas Engine Troubleshooting Chart 24
Pump Troubleshooting Chart 25

Storage

Winter Storage 26
Long Term Storage 26
Protect Fuel System 26
Storing the Engine 27
Other Storage Tips 27

Specifications 28

Warranty

Limited Warranty Statement 29
CARB and EPA Warranty Statement 31



Attention: Read through the complete manual prior to the initial use of your pressure washer.

Using the Operator's manual

The operator's manual is an important part of your pressure washer. It should be read thoroughly before initial use, and referred to often to make sure adequate safety and service concerns are being addressed.

Reading the operator's manual thoroughly will help avoid any personal injury or damage to your machine. By knowing how best to operate this machine, you will be better positioned to show others who may also operate the unit.

This manual was written to take you from the safety requirements to the operating functions of your machine. You can refer back to the manual at any time to help troubleshoot any specific operating functions, so store it with the machine at all times.

PRESSURE WASHER

If you need to contact an Authorized Dealer or Customer Service line for information on servicing, always provide the product model and identification numbers.

You will need to locate the model and serial number for the machine and record the information in the places provided below.

Date of Purchase:
Dealer Name:
Dealer Phone:

Product Identification Numbers
Model Number:
Serial Number:

To ensure trouble free warranty coverage it is important that you register your ECHO on-line at:

<http://www.echo-usa.com/Warranty/Register-Your-ECHO>

**IMPORTANT SAFETY INSTRUCTIONS
SAVE THESE INSTRUCTIONS**

WARNING – When using this product, the following precautions should always be observed and adhered to.

1. Read all instructions before using the product.
2. To reduce the risk of injury, close supervision is necessary when a product is used near children.
3. Know how to stop the product and bleed pressures quickly. Be thoroughly familiar with the controls. See page 21.
4. Stay alert – watch what you are doing.
5. Do not operate the product when fatigued or under the influence of alcohol or drugs.
6. Keep operating area clear of other people.
7. Do not overreach or stand on unstable support. Keep solid footing and balance at all times.
8. Follow the maintenance instructions specified in the manual.

Important Warnings

Failure to observe warnings will void warranty and/or cause injury.

1. Do not let the pressure washer overheat. Excess heat will cause severe damage (see below for details).
2. Never run the unit without water. Running the pump dry will cause it to quickly fail.
3. Do not let the unit freeze. Frozen water in the pump will cause serious damage.
4. Always wear eye protection when operating the unit.
5. High pressure spray can cause serious bodily injury or damage soft material. Use with caution.
6. Never adjust unloader to exceed the preset pressure. Premature wear, equipment failure, or injury may occur.

Engines are air cooled. It is important to ensure that machine is operated in a well-ventilated area where it can draw a steady supply of fresh air. The arrows below show an example of locations for air intake on an engine.

**PW-3100****PW-4200**

Pumps are water cooled. When the machine is running, ensure the trigger of the gun is pressed to allow a constant flow of fresh water into and out of the pump. Do not let the machine run for more than 30 seconds without pressing down on the trigger.

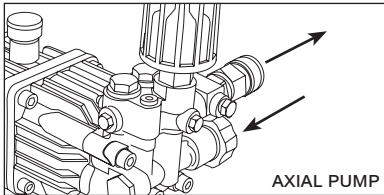
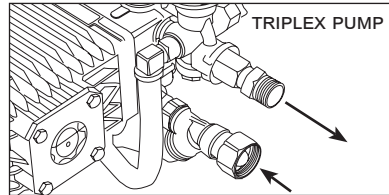
**AXIAL PUMP****TRIPLEX PUMP**

Most pumps are protected by a thermal valve. The thermal valve releases water if a pump starts to run too hot. It will prevent catastrophic heat failure. However, the pump may have suffered damage and need maintenance, repair, or replacement. If it does not reset and continues to leak water, the thermal valve may need to be replaced.

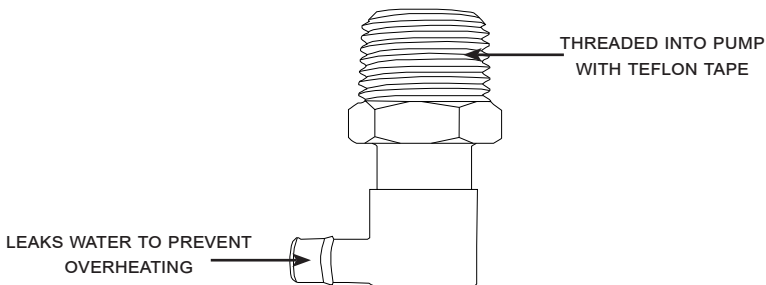

SAVE THESE INSTRUCTIONS

Safety Rules















This is the safety alert symbol. It is used to alert you to potential personal injury hazards. Obey all safety messages that follow this symbol to avoid possible injury or death.

The safety alert symbol () is used with a signal word (DANGER, CAUTION, WARNING), a pictorial and/or a safety message to alert you to hazards.

DANGER indicates a hazard which, if not avoided, will result in death or serious injury.
WARNING indicates a hazard which, if not avoided, could result in death or serious injury.
CAUTION indicates a hazard which, if not avoided, might result in minor or moderate injury.
NOTICE indicates a situation that could result in equipment or property damage.

Hazard Symbols and Meanings

			
EXPLOSION	FIRE	ELECTRIC SHOCK	TOXIC FUMES
			
KICKBACK	HOT SURFACE	FLYING OBJECTS	SLIPPERY
			
FALL	FLUID INJECTION	MOVING PARTS	READ MANUAL

⚠ WARNING

Fuel and its vapors are extremely flammable and explosive.

Fire or explosion can cause severe burns or death.

When Adding or Draining Fuel

- Turn pressure washer OFF and let it cool at least 2 minutes before removing fuel cap. Loosen cap slowly to relieve pressure in tank.
- Fill or drain fuel tank outdoors.
- DO NOT overfill tank. Always allow space for fuel expansion.
- If fuel spills, wait until it evaporates before starting engine.
- Keep fuel away from sparks, open flames, pilot lights, heat, and other ignition sources.
- DO NOT light a cigarette or smoke.

When Starting Equipment

- Ensure spark plug, muffler, fuel cap, and air cleaner are in place.
- DO NOT crank engine with spark plug removed.

When Operating Equipment

- DO NOT tip engine or equipment at angle which causes fuel to spill.
- DO NOT spray flammable liquids.

When Transporting or Repairing Equipment

- Transport/repair with fuel tank EMPTY or with fuel shutoff valve OFF.
- Disconnect spark plug wire.

When Storing Fuel or Equipment with Fuel in Tank

- Store away from furnaces, stoves, water heaters, clothes dryers, or other appliances that have pilot light or other ignition source because they can ignite fuel vapors.

**WARNING**
ADVERTENCIA • AVERTISSEMENT

Cancer and Reproductive Harm
Cáncer y Daño Reproductivo
Cancer et dommages à la reproduction

www.P65Warnings.ca.gov

⚠ WARNING	
	<p>A running engine gives off carbon monoxide, an odorless, colorless, poison gas. Breathing carbon monoxide can cause headache, fatigue, dizziness, vomiting, confusion, seizures, nausea, fainting or death. Some chemicals or detergents may be harmful if inhaled or ingested, causing severe nausea, fainting, or poisoning.</p>
<ul style="list-style-type: none">• Operate pressure washer ONLY outdoors.• Keep exhaust gas from entering a confined area through windows, doors, ventilation intakes, or other openings.• DO NOT start or run engine indoors or in an enclosed area, even if windows and doors are open.• Use a respirator or mask whenever there is a chance that vapors may be inhaled.• Read all instructions with mask so you are certain the mask will provide the necessary protection against harmful vapors.	

⚠ WARNING	
	<p>Starter cord kickback (rapid retraction) can result in bodily injury. Kickback will pull hand and arm toward engine faster than you can let go.</p> <p>Broken bones, fractures, bruises, or sprains could result.</p>
<ul style="list-style-type: none">• NEVER pull starter cord without first relieving spray gun pressure.• When starting engine, pull cord slowly until resistance is felt and then pull rapidly to avoid kickback.• After each starting attempt, where engine fails to run, always point spray gun in safe direction and squeeze spray gun trigger to release pressure.• Firmly grasp spray gun with both hands when using high pressure spray to avoid injury when spray gun kicks back.	

⚠ WARNING	
	<p>Risk of electrocution.</p> <p>Contact with power source can cause electric shock or burn.</p>
<ul style="list-style-type: none">• NEVER spray near a power source.	

⚠ WARNING

Use of pressure washer can create puddles and slippery surfaces.



Kickback from spray gun can cause you to fall.

- Operate pressure washer from a stable surface.
- The cleaning area should have adequate slopes and drainage to reduce the possibility of a fall due to slippery surfaces.
- Be extremely careful if you must use the pressure washer from a ladder, scaffolding, or any other similar location.
- Firmly grasp spray gun with both hands when using high pressure spray to avoid injury when spray gun kicks back.

⚠ WARNING

Contact with muffler area can result in serious burns.



Exhaust heat/gases can ignite combustibles, structures or damaged fuel tank causing a fire.

- DO NOT touch hot parts and AVOID hot exhaust gases.
- Allow equipment to cool before touching.
- Keep at least 5 feet (1.5 m) of clearance on all sides of pressure washer including overhead.

⚠ WARNING

Risk of eye injury.

Spray can splash back or propel objects.

- Always wear safety goggles when using this equipment or in vicinity of where equipment is in use.
- Before starting the pressure washer, be sure you are wearing adequate safety goggles.
- NEVER substitute safety glasses for safety goggles.

⚠ WARNING	
	<p>The high pressure stream of water that this equipment produces can cut through skin and its underlying tissues, leading to serious injury and possible amputation.</p> <p>Spray gun traps high water pressure, even when engine is stopped and water is disconnected, which can cause injury.</p>
<ul style="list-style-type: none">• DO NOT allow children to operate the pressure washer.• NEVER repair the high pressure hose. Replace it.• NEVER repair leaking connections with sealant of any kind. Replace o-ring or seal.• NEVER connect high pressure hose to nozzle extension.• Keep high pressure hose connected to pump and spray gun while system is pressurized.• ALWAYS point spray gun in safe direction and squeeze spray gun trigger to release high pressure every time you stop engine.• NEVER aim spray gun at people, animals, or plants.• DO NOT leave spray gun unattended while machine is running.• NEVER use a spray gun which does not have a trigger lock or trigger guard in place and in working order.• Always be certain spray gun, nozzles and accessories are correctly attached before spraying water.	

⚠ WARNING	
	<p>Starter and other rotating parts can entangle hands, hair, clothing, or accessories.</p>
<ul style="list-style-type: none">• NEVER operate pressure washer without protective housing or covers.• DO NOT wear loose clothing, jewelry or anything that may be caught in the starter or other rotating parts.• Tie up long hair and remove jewelry.	

WARNING

Unintentional sparking can result in fire or electric shock.

When Adjusting or Making Repairs to Your Pressure Washer

- Disconnect the spark plug wire from the spark plug and place the wire where it cannot contact spark plug.

When Testing for Engine Spark

- Use approved spark plug tester.
- DO NOT check for spark with spark plug removed.

NOTICE

High pressure spray may damage fragile items including glass.

- DO NOT point spray gun at glass when using red 0° spray tip.
- NEVER aim spray gun at plants.

NOTICE

Improper treatment of pressure washer can damage it and shorten its life.

- If you have questions about intended use, contact your nearest authorized dealer, call our support line, or visit our website.
- NEVER operate units with broken or missing parts, or without protective housing or covers.
- DO NOT by-pass any safety device on this machine.
- DO NOT tamper with governed speed.
- DO NOT operate pressure washer above rated pressure.
- DO NOT modify pressure washer in any way.
- Before starting pressure washer in cold weather, check all parts of the equipment to be sure ice has not formed.
- NEVER move machine by pulling on hoses. Use the handle provided on unit's frame.
- Check fuel system for leaks or signs of deterioration, such as chafed or spongy hose, loose or missing clamps, and damaged tank or cap.

Correct all defects before operating pressure washer.

Your pressure washer requires some assembly and is ready for use after it has been properly serviced with the recommended oil and fuel. We recommend **SAE 10W30** Oil for engines.

If you have any problems with the assembly of your pressure washer, please call our support line. If calling for assistance, please have the model and serial number from the data tag available.

Unpack the Pressure Washer

1. Remove the parts bag, accessories, and inserts included with pressure washer.
2. Open box completely by cutting each corner from top to bottom.
3. Ensure all contents are present prior to assembly.

Attach Handle

1. Place handle (A) onto handle supports (B) connected to main unit. Make sure holes (C) in handle align with holes on handle supports.

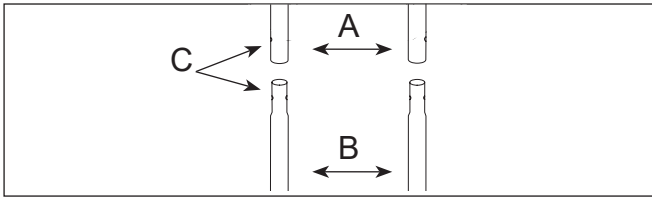

NOTE: These diagrams are intended for general reference. As a result, they may not fully reflect the appearance of your product.

2. Insert carriage bolts through holes from outside of unit and attach a plastic knob from inside of unit. Tighten by hand.

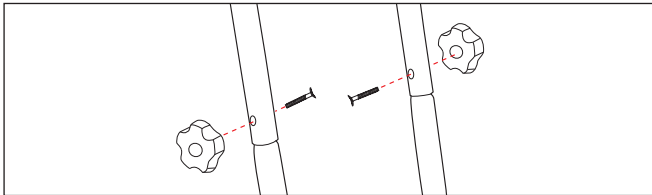

3. Insert multi-colored quick connect spray tips and other supplied accessories in spaces provided on handle.

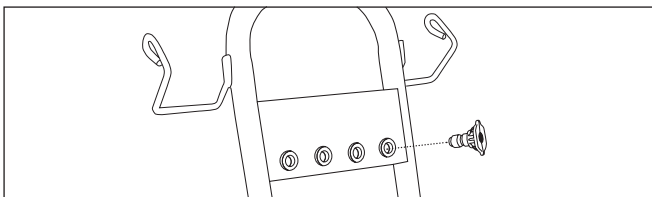

The following diagrams are intended for general reference.

Your pressure washer may differ from the models shown in the following pages. For specific model information, please visit contact us.

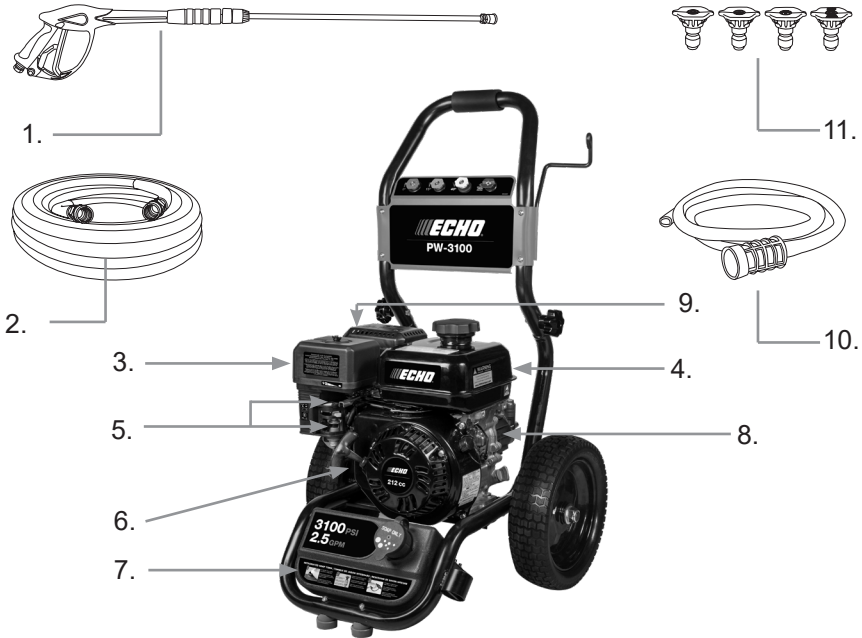

1. Spray Gun - Controls the application of water onto cleaning surface with trigger device. Includes trigger lock. Allows you to switch between various spray tips.
2. High Pressure Hose - Designed to withstand the pressure created by the pump.
3. Air Filter - Protects the engine by filtering dust and debris out of intake air.
4. Fuel Tank - Fill tank with regular, unleaded fuel. Always leave room for fuel expansion.
5. (Top) Choke Rod - Prepares a cold engine for starting.
(Bottom) Throttle Lever - Sets engine in starting mode for recoil starter.
6. Recoil Starter - Used for starting the engine manually.
7. Soap Tank - (Not included on all models) Fill with pressure washer detergent only.
8. Pump - Develops high pressure. Connect the garden hose to the inlet of the water pump, and connect the high-pressure hose to the outlet. Connections vary by model.
9. Muffler/Exhaust - Reduces noise of the engine and expels heat.
10. Detergent Siphoning Hose - Used to draw detergent into the low pressure stream.
11. Spray Tips - Detergent, 0°, 15°, and 40°: for various cleaning applications.

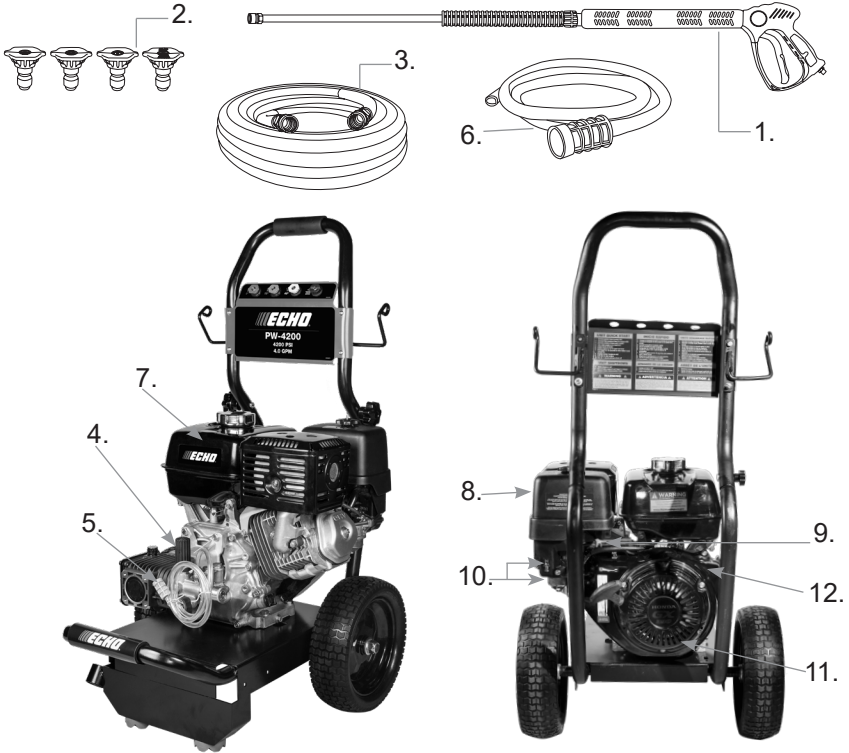



1. Spray Gun Controls the application of water onto cleaning surface with trigger device. Includes trigger lock. Allows you to switch between various spray tips.
2. Spray Tips Detergent, 0°, 15°, and 40°: for various high pressure cleaning applications.
3. High Pressure Hose Designed to withstand the pressure generated by the pump.
4. Unloader Pressure is preset at the factory.
5. Pump Develops high pressure. Connect the garden hose to the inlet of the water pump, and connect the high-pressure hose to the outlet.
6. Detergent Siphoning Hose Use to siphon pressure washer safe detergent into the low pressure stream.
7. Fuel Tank Fill tank with regular unleaded fuel. Always leave room for fuel expansion.
8. Air Filter Protects engine by filtering dust and debris out of intake air.
9. Throttle Lever Sets engine in starting mode for recoil starter.
10. (Top) Choke Lever Prepares a cold engine for starting.
(Bottom) Fuel Valve Used to turn fuel supply on and off to engine.
11. Recoil Starter Used for starting the engine manually.
12. Engine Switch Set switch to "On" for recoil starting. Set switch to "Off" to stop a running engine.

Follow the steps below prior to using the machine every time.



1. Check to ensure the engine oil is at the proper level. **Use SAE 10W30 Oil**
2. Check the 2 handle knobs in the frame to ensure they are tight and will not vibrate loose.
3. Add fuel to the gas tank. Be careful not to spill while filling and do not overfill. We recommend using fuel with the lowest amount of ethanol possible. 87 octane and up is suitable.
4. Connect and tighten the garden hose to the GHA (garden hose inlet) connection.
5. Connect high pressure hose to the pump outlet. Connect the other end to the spray gun.

**** Water must be turned on prior to starting the washer, pull the spray trigger to ensure water is moving through the lines and out the nozzle without any leaks before starting the unit.****

6. Review the safety guidelines in the manual prior to starting the unit. If you have any issues operating the pressure washer, call our customer service line.

 NOTICE	
 oil	Always check the level of the engine oil prior to starting the washer. Level should be at about halfway up the sight glass. If your unit does not have one, use the oil dipstick. The level should be about halfway up the dipstick.
• Failure to do so could cause the engine to seize if the oil is low or empty.	

Connect Hose and Water Supply to Pump Before Starting

 NOTICE	
	DO NOT start your pressure washer without the water supply turned on.
• Failure to do so will result in damaging the pump from overheating and void the warranty.	

Garden hose should be no longer than 50 feet and no smaller than 5/8 inches in diameter, do not use expanding garden hoses.

How to Start Your Pressure Washer

To start your pressure washer for the first time, follow these instructions step-by-step. This starting information also applies if you have let the pressure washer sit idle for at least a day.

1. Place pressure washer near an outside water source capable of supplying water at a flow rate at least 1 GPM greater than the rated flow of your pressure washer. It should also be no less than 20 PSI at pressure washer end of garden hose. **DO NOT** siphon standing water.
2. Make sure unit is in a level position.
3. Connect garden hose to water inlet on pressure washer pump.

NOTICE	
DO NOT run the pump without the water supply connected and turned on.	
• Damage to equipment resulting from failure to follow this instruction will void warranty.	

4. Attach wand extension to spray gun. Tighten by hand.

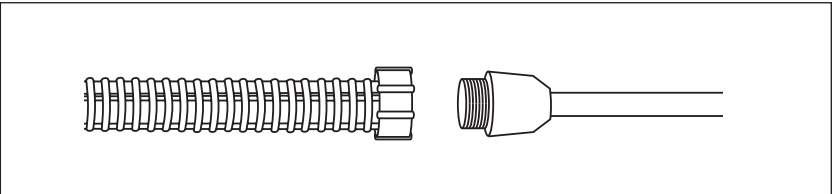

5. Choose desired spray tip, pull back nozzle extension collar, insert spray tip and release collar. Tug on spray tip to make sure it is securely in place. See *Spray Tips*.

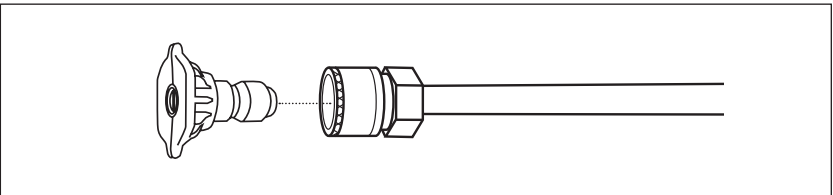

- If your gun uses a quick-connect, pull down on the collar of the quick connect coupler, slide onto the gun and let go of collar. Pull on hose to ensure the connection is tight. If your gun uses an M22 fitting, simply thread the connections together until secure.

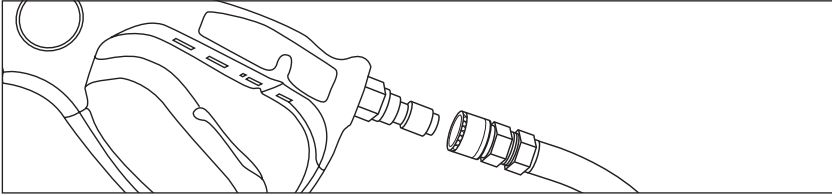
**⚠ WARNING**

The high pressure stream of water that this equipment produces can cut through skin and its underlying tissues, leading to serious injury and possible amputation.

- NEVER connect high pressure hose directly to nozzle extension.
- Keep high pressure hose connected to pump and spray gun while system is pressurized.

- Attach the other end of the high pressure hose to high pressure outlet (A) on pump. Pull down on collar of quick connect, slide onto pump and let go of collar. Note that some pumps require the hose to be threaded on. Tug on the hose to ensure connection is secure.

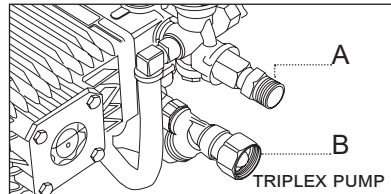
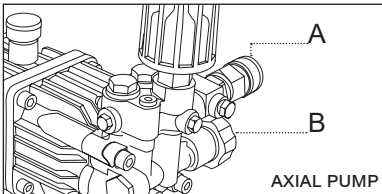

***Pump Uses SAE30 Non-Detergent Mineral Oil**

- Turn Water Supply on if you have not already done so. Point the gun in a safe direction and squeeze the trigger to purge the pump of air and debris. Do this until water flow is no longer erratic.
- Take a final look at all connections to make sure there are no leaks or loose connections. If there are any leaks in hoses, they must be replaced.



IMPORTANT: DO NOT siphon standing water for the water supply.

Use COLD WATER only (less than 100°F/38°C). Hot water will damage seals and compromise the integrity of your pump.

10. To start the machine, locate the engine switch on the side of the engine (if applicable), and switch it to the ON position. Units with a Honda GC engine have the power switch built into the throttle lever. Check to ensure fuel valve is in the ON position and if starting cold, apply the choke. Reference the component diagrams for the location of these parts.
11. Brace the unit with your foot and ensure that you are completely balanced on a flat surface. Pull recoil cord slowly until resistance is felt and then pull rapidly to avoid kickback. DO NOT place hand on engine muffler for balance as this will result in a severe burn. Once the engine is running, disengage the choke lever.

 WARNING	
	<p>A running engine produces carbon monoxide, an odorless, colorless, poison gas.</p> <p>Breathing carbon monoxide can cause headaches, fatigue, dizziness, vomiting, confusion, seizures, nausea, fainting, and death.</p>
<ul style="list-style-type: none">• Operate pressure washer outdoors, never indoors.• Keep exhaust gas from entering a confined area through windows, doors, ventilation intakes, or other openings.• DO NOT start or run engine indoors or in an enclosed area, even if windows and doors are open.	

IMPORTANT: Before starting the pressure washer, ensure you are wearing adequate safety goggles.

 WARNING	
	<p>Risk of eye injury.</p> <p>Spray can splash back or propel objects such as rocks, dirt and other debris.</p>
<ul style="list-style-type: none">• Always wear safety goggles when using this equipment or while in vicinity of where equipment is in use.• NEVER substitute normal glasses for safety goggles.	

⚠ WARNING

The high pressure stream of water that this equipment produces can cut through skin and its underlying tissues, leading to serious injury and possible amputation.

Spray gun traps high water pressure, even when engine is stopped and water is disconnected, which can cause injury.

- DO NOT allow CHILDREN to operate pressure washer.
- NEVER repair high pressure hose. Replace it.
- NEVER repair leaking connections with sealant of any kind. Replace the o-ring or seal.
- NEVER connect high pressure hose directly to the spray nozzle.
- Keep high pressure hose connected to pump and spray gun while system is pressurized.
- ALWAYS point spray gun in safe direction and squeeze spray gun trigger, to release high pressure, every time you stop engine.
- NEVER aim spray gun at people, animals, or plants.
- DO NOT secure spray gun in open position.
- DO NOT leave spray gun unattended while machine is running.
- NEVER use a spray gun which does not have a trigger lock or trigger guard in place and in working order.
- ALWAYS be certain spray gun, nozzles and accessories are correctly attached. Failure to do so can result in damage to the unit or bodily harm.

⚠ WARNING

Contact with muffler area can result in serious burns.



Exhaust heat/gases can ignite combustibles, structures or damage fuel tank causing a fire.

- DO NOT touch hot parts and avoid hot exhaust gases.
- Allow equipment to cool for at least 15 minutes before touching.
- Keep at least 5 feet (1.5 m) of clearance on all sides of pressure washer (including overhead) while in operation.

How to Shut Your Pressure Washer Down

1. Release spray gun trigger and let engine idle down.
2. Turn the engine switch to the OFF position.
3. ALWAYS point spray gun in a safe direction, squeeze spray gun trigger to release retained high water pressure.

IMPORTANT: Spray gun traps high water pressure, even when engine is stopped and water is disconnected. Couplers will not release if under pressure.

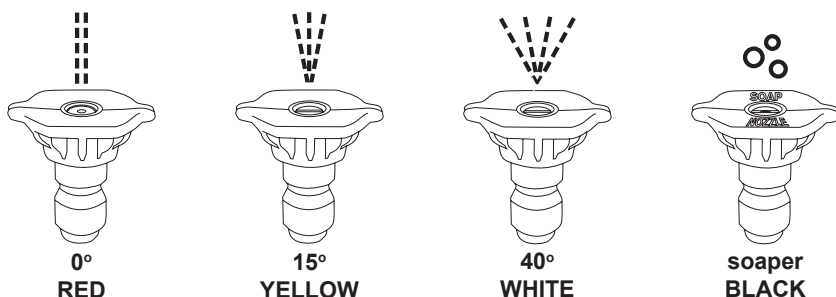

How to Use Spray Tips

The quick-connect on the nozzle extension allows you to switch between four different quick connect spray tips. Spray tips can be changed while the pressure washer is running once the spray gun trigger safety lock is engaged. The spray tips vary the spray pattern as shown above.

Follow these instructions to change spray tips:

1. Pull back collar on quick-connect coupler and pull the current spray tip off. Store the spray tips in the holder provided on the handle. Storing nozzles in the designated holder will help prevent any debris from clogging the tip.
2. Select the desired spray tip:
 - For a gentle rinse, select the white 40° spray tip.
 - For high pressure cleaning, select the yellow 15° spray tip.
 - To scour the surface, select the red 0° spray tip.
 - To apply detergent, select the black spray tip.
3. Pull back on collar, insert new spray tip and release collar. Tug on spray tip to make sure it is securely in place.

Usage Tips

- For most effective cleaning, keep spray tip 8"(20.3cm) to 24"(61cm) away from cleaning surface.
- If you get spray tip too close, especially using a high pressure spray tip (red or yellow), you may damage the surface being cleaned. **Do not use the red spray tip on glass.**



To apply detergent, follow these steps:

1. Review the use of spray tips.
2. Prepare detergent solution as required by the job. Use only certified detergent.
3. Place the small filter end of detergent siphoning tube into detergent container or on-board soap tank (if applicable).
4. Connect the other end of the soap hose to the pressure washer pump.

NOTE: Make sure the filter is fully submerged in detergent during use.

Please note that only the BLACK NOZZLE will draw soap.

5. Ensure that the black spray tip is installed.
6. Make sure the garden hose is connected to the water inlet. Check that the high pressure hose is connected to spray gun and pump. Turn water on.

NOTICE	
You must attach all hoses before you start the engine.	
<ul style="list-style-type: none">• Starting the engine without all the hoses connected and without the water turned ON will damage the pump.• Damage to equipment resulting from failure to follow this instruction is not covered by warranty.	

7. Start the engine following instructions in *Starting Your Washer*.
8. Apply the detergent to the surface using long, even, overlapping strokes.
9. Allow the detergent to “soak in” for 5 minutes before washing and rinsing.

Reapply as needed to prevent surface from drying. **DO NOT allow detergent to dry on.** This will damage paint clear coat, and other types of finish.

IMPORTANT: You must flush the detergent siphoning system after each use by placing the filter into a bucket of clean water and running the pressure washer at low pressure for 1-2 minutes.

 CAUTION	
Chemicals can cause bodily harm and/or property damage.	
<ul style="list-style-type: none">• NEVER use caustic liquid with pressure washer.• Use ONLY pressure washer safe detergent/soaps. Follow all manufacturer instructions and do not mix detergents with other types.	

Troubleshooting Chart

If you are experiencing an issue that is not listed in this chart, or have checked all the possible causes listed and are still experiencing the problem, see your authorized dealer or call our support line.

GASOLINE ENGINES

Problem	Cause	Correction
Unit has following problems: failure to produce pressure, erratic pressure, chattering, loss of pressure, low water volume.	<ol style="list-style-type: none"> 1. Low pressure spray tip installed. 2. Water inlet is blocked. 3. Inadequate water supply. 4. Inlet hose is kinked or leaking. 5. Clogged inlet hose screen. 6. Water supply is over 100°F (38°C). 7. High pressure hose is blocked or leaks. 8. Spray gun leaks. 9. Spray tip is obstructed. 10. Pump is faulty. 	<ol style="list-style-type: none"> 1. Replace with high pressure spray tip. 2. Clear inlet. 3. Provide adequate water flow. 4. Straighten inlet hose. Replace if leaking. 5. Check and clean inlet hose screen. 6. Provide cooler water supply. 7. Clear blocks in outlet hose. 8. Replace spray gun. 9. Clean spray tip. 10. Contact local service facility.
Detergent fails to mix with spray.	<ol style="list-style-type: none"> 1. Detergent siphoning tube is not submerged. 2. Detergent siphoning tube/filter is clogged or cracked. 3. High pressure spray tip installed. 	<ol style="list-style-type: none"> 1. Fully submerge detergent siphoning tube into detergent. 2. Clean or replace filter/ siphoning tube. 3. Replace with low pressure spray tip.
Engine lacks power.	<ol style="list-style-type: none"> 1. Dirty air filter. 	<ol style="list-style-type: none"> 1. Replace air filter.
Engine will not start	<ol style="list-style-type: none"> 1. Throttle lever or on/off switch in OFF position. 2. No fuel in engine 3. Worn, fouled, or dirty spark plug 4. Pressure build up in pump 	<ol style="list-style-type: none"> 1. Turn throttle lever to ON position 2. Fill fuel tank or turn on fuel supply 3. Replace with factory recommended spark plug 4. Squeeze trigger on spray wand (refer to operating instructions in owner's manual)
Oil Alert (for units with this feature)	Engine isn't level or the oil level is too low	Place engine on level surface or perform an oil change using SAE 10W30 oil (refer to engine user manual for instructions)
Engine runs well at no load but "bogs" down under full load	<ol style="list-style-type: none"> 1. Engine speed is too slow 	<ol style="list-style-type: none"> 1. Adjust Throttle Lever back to full throttle.
Engine will not start or starts and runs poorly	<ol style="list-style-type: none"> 1. Low oil level 2. Dirty air filter 3. Out of gasoline 4. Stale gasoline 5. Spark plug wire not connected to spark plug 6. Bad spark plug 7. Water in gasoline 8. Over choking 	<ol style="list-style-type: none"> 1. Fill crankcase to proper level 2. Clean or replace air filter 3. Fill fuel tank 4. Drain gas tank and fill with fresh fuel 5. Connect wire to the spark plug 6. Replace the spark plug 7. Drain gas tank, fill with fresh fuel 8. Open choke fully and crank engine
Engine shuts down during operation	<ol style="list-style-type: none"> 1. Out of gasoline 2. Low oil level 	<ol style="list-style-type: none"> 1. Fill fuel tank 2. Fill crankcase to proper oil level
Engine lacks power	<ol style="list-style-type: none"> 1. Dirty air filter 	<ol style="list-style-type: none"> 1. Replace air filter
Engine "putts" or falters	<ol style="list-style-type: none"> 1. Choke is opened too soon/too early 	<ol style="list-style-type: none"> 1. 1. Move choke to halfway position until engine runs smoothly. <p>* All engine servicing to be taken to manufacturer's authorized service outlet</p>

Engine will not start	<ol style="list-style-type: none"> 1. Throttle lever or on/off switch in OFF position. 2. No fuel in engine 3. Worn, fouled, or dirty spark plug 4. Pressure build up in pump 	<ol style="list-style-type: none"> 1. Turn throttle lever to ON position 2. Fill fuel tank or turn on fuel supply 3. Replace with factory recommended spark plug 4. Squeeze trigger on spray wand (refer to operating instructions in owner's manual)
Oil Alert (for units with this feature)	Engine isn't level or the oil level is too low	Place engine on level surface or perform an oil change using SAE 10W30 oil (refer to engine user manual for instructions)
Engine runs well at no load but "bogs" down under full load	<ol style="list-style-type: none"> 1. Engine speed is too slow 	<ol style="list-style-type: none"> 1. Adjust Throttle Lever back to full throttle.
Engine will not start or starts and runs poorly	<ol style="list-style-type: none"> 1. Low oil level 2. Dirty air filter 3. Out of gasoline 4. Stale gasoline 5. Spark plug wire not connected to spark plug 6. Bad spark plug 7. Water in gasoline 8. Over choking 	<ol style="list-style-type: none"> 1. Fill crankcase to proper level 2. Clean or replace air filter 3. Fill fuel tank 4. Drain gas tank and fill with fresh fuel 5. Connect wire to the spark plug 6. Replace the spark plug 7. Drain gas tank, fill with fresh fuel 8. Open choke fully and crank engine
Engine shuts down during operation	<ol style="list-style-type: none"> 1. Out of gasoline 2. Low oil level 	<ol style="list-style-type: none"> 1. Fill fuel tank 2. Fill crankcase to proper oil level
Engine lacks power	<ol style="list-style-type: none"> 1. Dirty air filter 	<ol style="list-style-type: none"> 1. Replace air filter
Engine "putts" or falters	<ol style="list-style-type: none"> 1. Choke is opened too soon/too early 	<ol style="list-style-type: none"> 1. Move choke to halfway position until engine runs smoothly. * All engine servicing to be taken to manufacturer's authorized service outlet

PUMP

Problem	Causes	Correction
No low pressure detergent delivery	<ol style="list-style-type: none"> 1. Using wrong nozzle 2. Siphon hose or filter is plugged 	<ol style="list-style-type: none"> 1. Insert black soaper nozzle 2. Clear siphon hose of debris
Unit does not reach required pressure	<ol style="list-style-type: none"> 1. Restricted or insufficient water supply 2. Unsuitable or worn out nozzle 3. Regulator set too low (for units with an adjustable unloader) 	<ol style="list-style-type: none"> 1. Check supply hose, faucet and inlet water filter. Must be connected to water source that provides at least 6 GPM 2. Replace nozzle 3. Reset unloader by turning knob (clockwise increases pressure)

Thermal Relief Valve is open and discharging water from side of pump	<ol style="list-style-type: none"> 1. Water temperature is too high 2. Pump has operated more than 3 mins without pulling trigger 	<ol style="list-style-type: none"> 1. Use cool water only. 2. Pull trigger at least 30 seconds every 3 mins. Thermal valve must be replaced.
Leak in the fittings	<ol style="list-style-type: none"> 1. Water leak in high pressure fittings, hose, or gun 	<ol style="list-style-type: none"> 1. Use teflon tape or pipe sealant to tighten hose fitting, replace hose or gun *If problem continues, take to your pressure washer dealer
Pump oil is low	<ol style="list-style-type: none"> 1. Normal use consumes oil over time 	<ol style="list-style-type: none"> 1. PW-3100 pump is sealed (no oil change needed), PW-4200 pump oil pump oil needs to be changed at the first 50 hours and then at the next 500 hour intervals
Oil has a milky color	<ol style="list-style-type: none"> 1. Seals have worn from use and water has leaked in 	<ol style="list-style-type: none"> 1. Bring Unit local service center to have seals replaced

Winter Storage

NOTICE

You must protect your unit from freezing temperatures.

1. Failure to do so will permanently damage your pump and render your unit inoperable.
2. **Freezing damage is not covered under warranty.**

To protect the unit from freezing temperatures:

1. Use a commercially available pump protector to treat the pump. This minimizes freezing damage and lubricates pistons and seals. Contact your authorized dealer for pump protector solution.
2. If pump protector solution is not available, connect a 3 ft. (30.5cm) section of garden hose to the water inlet adapter. Pour RV-antifreeze (antifreeze without alcohol) into hose. Pull the recoil handle twice. Disconnect the 3 ft. (30.5cm) hose.
3. Store the unit in a clean, dry area (heated area preferred).

Long Term Storage

If you do not plan to use the pressure washer for more than 30 days, you must prepare the engine and pump for long term storage. See the engine user manual for specific instructions regarding this.

Protect Fuel System

Fuel Stabilizer:

Fuel will become stale when stored over 30 days. Stale fuel causes acids and gum deposits to form in the fuel system or on essential carburetor parts. Prior to storage, if gasoline will not be treated with a fuel stabilizer, it must be drained from the engine into an approved container. After draining, run the engine until it stops from lack of fuel.

When fuel stabilizers are used according to their instructions, there is no need to drain the gasoline from the engine prior to storage. Run the engine for a short time to circulate stabilizer throughout the fuel system. Engine and fuel can then be stored for up to 24 months.

If gasoline is drained, the use of a fuel stabilizer in the storage container is still recommended to maintain freshness.

Storing the Engine



See the engine operator’s manual for instructions on how to properly prepare the engine for storage.

NOTE: Pump protector solution is available as an optional accessory. It is not included with the pressure washer. Contact your closest authorized dealer to purchase pump protector solution.

To use pump protector solution, make sure the pressure washer is turned off and disconnected from supply water. Read and follow all instructions and warnings given on the pump protector solution container.

Other Storage Tips

1. DO NOT store fuel from one season to another unless it has been treated as described in *Protect Fuel System*.
2. Replace the fuel container if it starts to rust. Rust and/or dirt in fuel can cause problems if it’s used with this unit.
3. Cover unit with a suitable protective cover that does not retain moisture.

 WARNING	
	Storage covers can be flammable.
<ul style="list-style-type: none">• DO NOT place a storage cover over a hot pressure washer.• Let equipment cool for at least 30 minutes before placing the cover on the equipment.	

4. Store unit in a clean and dry area.



SPECIFICATIONS

	PW-3100	PW-4200
Description	ECHO PW 3100PSI, 2.5GPM, 212CC	ECHO PW 4200PSI, 4GPM, 389CC
PSI	3100	4200
GPM	2.5	4
Engine Model	R210	GX390
Displacement	212cc	389cc
Engine speed	3450 RPM	3450 RPM
Engine Torque	8.85 lb-ft (12 Nm) @ 2,500 rpm	19.5 lb-ft (26.4 Nm) @ 2,500 rpm
Engine Horsepower	7	13
Pump Type	Axial	Triplex
Spray Tips Included and size number	4x (#3.0)	4x (#4.0)
Detergent tank capacity	3.5 litres (0.92 U.S. gal)	N/A
Hose length	25'	50'
Start Type	Recoil start	Recoil start
Fuel Capacity	3.6 litres (0.95 U.S. gal)	6.1 litres (1.61 U.S. gal)
Engine Oil Capacity	0.6 litres (0.63 U.S. qts)	1.1 litres (1.16 U.S. qts)
Weight	16.1 kg (35 lbs)	31.5 kg (69 lbs)
Dimensions (L x W x H)	385 mm (15.1") 340 mm (13.3") 340 mm (13.3")	407 mm (16") 485 mm (19.1") 449 mm (17.7")
Hose diameter	3/8"	3/8"
Hose Material	Rubber	Rubber

LIMITED WARRANTY STATEMENT

ECHO Incorporated warrants to the original retail purchaser that this ECHO® brand outdoor product is free from defects in material and workmanship and agrees to repair or replace at ECHO Incorporated's discretion, any defective product free of charge within these time periods from the date of purchase. This warranty statement applies to gasoline model Power Washers.

- 3 Year Consumer – 1 Year on Axial Cam Pump
- 1 Year Commercial – 90 Days on Axial Cam Pump (PW-4200 Model carries a 3 year warranty on the engine if used commercially)
- 90 Days – For Rental Use (PW-4200 Model carries a 3 year warranty on the engine if used for rental purposes)
- 90 Days Accessories and Replacement Parts – Included but not limited to Guns, Wands, Nozzles, Hoses, Couplers.

This warranty extends to the original retail purchaser only and commences on the date of the original retail purchase.

Any part of this product found, in the reasonable judgment of ECHO Incorporated, to be defective in material or workmanship will be repaired or replaced without charge for parts and labor by an authorized ECHO dealer. Repair parts and accessories replaced under this warranty are warranted only for the balance of the original warranty period.

The product, including any defective part, must be returned to an authorized ECHO dealer within the warranty period. The expense of delivering the product to the dealer for warranty work and the expense of returning it back to the owner after repair or replacement will be paid by the owner. ECHO Incorporated's responsibility in respect to claims is limited to making the required repairs or replacements and no claim of breach of warranty shall be cause for cancellation or rescission of the contract of sale of any ECHO brand outdoor product. Proof of purchase will be required by the dealer to substantiate any warranty claim. All warranty work must be performed by an authorized ECHO dealer.

This warranty does not cover any product that has been subject to misuse, neglect, negligence, or accident, or that has been operated in any way contrary to the operating instructions as specified in this Operator's Manual. This warranty does not apply to any damage to the product that is the result of improper maintenance or to any product that has been altered or modified. The warranty does not extend to repairs made necessary by normal wear or by the use of parts or accessories which are either incompatible with the ECHO brand outdoor product, or that adversely affect its operation, performance, or durability. In addition, this warranty does not cover wear to normal items such as, but not limited to:

-
- A. Tune-ups – Air filters, gas filters, carburetors, spark plugs, filters, oil changes
 - B. Wear items – Hoses, connector fittings, spray nozzles, trigger handle, spray wand, wheels, detergent bucket, detergent tank
 - C. **IMPORTANT: Some components not covered under this warranty may still be covered by a separate warranty issued by the engine manufacturer. Please see the Engine Manufacturer Warranty (if any) supplied with this product for further details.**

ECHO Incorporated reserves the right to change or improve the design of this product without assuming any obligation to modify any product previously manufactured.

All implied warranties are limited in duration to the stated warranty period. Accordingly, any such implied warranties including merchantability, fitness for a particular purpose, or otherwise, are disclaimed in their entirety after the expiration of the appropriate three-year or one-year or 90 day warranty period. Echo Incorporated's obligation under this warranty is strictly and exclusively limited to the repair or replacement of defective parts and echo incorporated does not assume or authorize anyone to assume for them any other obligation. Some states do not allow limitations on how long an implied warranty lasts, so the above limitation may not apply to you. Echo incorporated assumes no responsibility for incidental, consequential, or other damages including, but not limited to, expense of returning the product to an authorized dealer for echo brand outdoor products and expense of delivering it back to the owner, mechanic's travel time, telephone or telegram charges, rental of a like product during the time warranty service is being performed, travel, loss or damage to personal property, loss of revenue, loss of use of the product, loss of time, or inconvenience. Some states do not allow the exclusion or limitation of incidental or consequential damages, so the above limitation or exclusion may not apply to you.

This warranty gives you specific legal rights, and you may also have other rights which vary from state to state.

This warranty applies to gasoline model ECHO brand Power Washers manufactured by or for ECHO Incorporated and sold in the United States and Canada.

To locate your nearest authorized ECHO dealer, visit www.echo-usa.com or dial 1-800-432-ECHO (3246).

ECHO Incorporated
400 Oakwood Rd. Lake Zurich, IL 60047
1-800-432-ECHO (3246)
www.echo-usa.com

CALIFORNIA AND FEDERAL EXHAUST AND EVAPORATIVE EMISSIONS CONTROL WARRANTY STATEMENT

YOUR WARRANTY RIGHTS AND OBLIGATIONS

The California Air Resources Board, the United States Environmental Protection Agency and Chongqing Rato Technology Co., Ltd. (Rato), are pleased to explain the exhaust and evaporative emissions (“emissions”) control system warranty on your 2019/2020 small off-road engine/equipment.

In California, new equipment that use small off-road engines must be designed, built, and equipped to meet the State’s stringent anti-smog standards. Rato must warrant the emissions control system on your small off-road engine/equipment for the period listed below provided there has been no abuse, neglect or improper maintenance of your small off-road engine/equipment leading to the failure of the emissions control system.

Your emissions control system may include parts such as the carburetor or fuel-injection system, the ignition system, catalytic converter, fuel tanks, fuel lines (for liquid fuel and fuel vapors), fuel caps, valves, canisters, filters, clamps and other associated components. Also included may be hoses, belts, connectors, and other emission-related assemblies.

Where a warrantable condition exists, Rato will repair your small off-road engine/equipment at no cost to you including diagnosis, parts and labor.

MANUFACTURER’S WARRANTY COVERAGE

The exhaust and evaporative emissions control system on your small off-road engine/equipment is warranted for two years. If any emissions-related part on your small off-road engine/equipment is defective, the part will be repaired or replaced by Rato.

OWNER’S WARRANTY RESPONSIBILITIES

As the small off-road engine/equipment owner, you are responsible for performance of the required maintenance listed in your owner’s manual. Rato recommends that you retain all receipts covering maintenance on your small off-road engine/equipment, but Rato cannot deny warranty coverage solely for the lack of receipts or for your failure to ensure the performance of all scheduled maintenance.

As the small off-road engine/equipment owner, you should however be aware that Rato may deny your warranty coverage if your small off-road engine/equipment or a part has failed due to abuse, neglect, or improper maintenance or unapproved modifications.



You are responsible for presenting your small off-road engine/equipment to a Rato distribution center or service center as soon as the problem exists. The warranty repairs shall be completed in a reasonable amount of time, not to exceed 30 days.

If you have questions regarding your warranty coverage, you can email us at echo-usa.custhelp.com/app/ask or contact ECHO Incorporated at 1-800-432-ECHO (3246), web site information is available at WWW.ECHO-USA.COM.

DEFECTS WARRANTY REQUIREMENTS

- A. The warranty period begins on the date the small off-road engine/equipment is delivered to an ultimate purchaser.
- B. General Emissions Warranty Coverage. Rato warrants to the ultimate purchaser and each subsequent owner that the engine or equipment is: Designed, built, and equipped so as to conform with all applicable regulations adopted by the Air Resources Board; and Free from defects in materials and workmanship that causes the failure of a warranted part for a period of two years.
- C. The warranty on emission-related parts will be interpreted as follows:
 1. Any warranted part that is not scheduled for replacement as required maintenance in the written instructions must be warranted for the warranty period defined in Subsection (b)(2). If any such part fails during the period of warranty coverage, it must be repaired or replaced by Rato according to Subsection (4) below. Any such part repaired or replaced under the warranty must be warranted for the remaining warranty period.
 2. Any warranted part that is scheduled only for regular inspection in the written instructions must be warranted for the warranty period defined in Subsection (b)(2). A statement in such written instructions to the effect of "repair or replace as necessary" shall advise owners of the warranty coverage for emissions related parts. Replacement within the warranty period is covered by the warranty and will not reduce the period of warranty coverage. Any such part repaired or replaced under warranty must be warranted for the remaining warranty period.
 3. Any warranted part that is scheduled for replacement as required maintenance in the written instructions must be warranted for the period of time prior to the first scheduled replacement point for that part. If the part fails prior to the first scheduled replacement, the part must be repaired or replaced by Rato according to Subsection (4) below. Any such part repaired or replaced under warranty must be warranted for the remainder of the period prior to the first scheduled replacement point for the part.
 4. Repair or replacement of any warranted part under the warranty

provisions must be performed at no charge to the owner at a warranty station.

5. Notwithstanding the provisions of Subsection (4) above, warranty services or repairs must be provided at distribution centers that are franchised to service the subject engine/equipment.
6. The owner must not be charged for diagnostic labor that leads to the determination that a warranted part is in fact defective, provided that such diagnostic work is performed at a warranty station.
7. Rato is liable for damages to other engine/equipment components proximately caused by a failure under warranty of any warranted part.
8. Throughout the emissions control system's warranty period set out in subsection (b)(2), Rato must maintain a supply of warranted parts sufficient to meet the expected demand for such parts and must obtain additional parts if that supply is exhausted.
9. Manufacturer-approved replacement parts that do not increase the exhaust or evaporative emissions of the engine or emissions control system must be used in the performance of any warranty maintenance or repairs and must be provided without charge to the owner. Such use will not reduce the warranty obligations of Rato.
10. Add-on or modified parts that are not exempted by the Air Resources Board may not be used. The use of any non-exempted add-on or modified parts will be grounds for disallowing a warranty claim. Rato will not be liable to warrant failures of warranted parts caused by the use of a non-exempted add-on or modified part.
11. Rato issuing the warranty shall provide any documents that describe that warranty procedures or policies within five working days of request by the Executive Officer.

D - Emission Warranty Parts List for Exhaust

1. Fuel Metering System
 - Carburetor and internal parts (and/or pressure regulator or fuel injection system).
 - Air/fuel ratio feedback and control system.
 - Cold start enrichment system.
 2. Air Induction System
 - Controlled hot air intake system.
 - Intake manifold.
 - Air filter.
 3. Ignition System
 - Spark Plugs.
 - Magneto or electronic ignition system.
 - Spark advance/retard system.
 4. Exhaust Gas Recirculation (EGR) System
 - EGR valve body, and carburetor spacer if applicable.
-

- EGR rate feedback and control system.
- 5. Air Injection System
 - Air pump or pulse valve.
 - Valves affecting distribution of flow.
 - Distribution manifold.
- 6. Catalyst or Thermal Reactor System
 - Catalytic converter.
 - Thermal reactor.
 - Exhaust manifold.
- 7. Particulate Controls
 - Traps, filters, precipitators, and any other device used to capture particulate emissions.
- 8. Miscellaneous Items Used in Above Systems
 - Electronic controls.
 - Vacuum, temperature, and time sensitive valves and switches.
 - Hoses, belts, connectors, and assemblies.

E - Emission Warranty Parts List for Evap

1. Fuel Tank
2. Fuel Cap
3. Fuel Lines (for liquid fuel and fuel vapors)
4. Fuel Line Fittings
5. Clamps*
6. Pressure Relief Valves*
7. Control Valves*
8. Control Solenoids*
9. Electronic Controls*
10. Vacuum Control Diaphragms*
11. Control Cables*
12. Control Linkages*
13. Purge Valves*
14. Gaskets*
15. Liquid/Vapor Separator
16. Carbon Canister
17. Canister Mounting Brackets
18. Carburetor Purge Port Connector

*Note: As they relate to the evaporative emission control system.

Rato will furnish with each new small off-road engine/equipment written instructions for the maintenance and use of the engine/equipment by the owner.



**IF YOU NEED ASSISTANCE WITH THE ASSEMBLY OR OPERATION
OF THESE PRESSURE WASHERS, PLEASE CONTACT US AT:**

ECHO Incorporated
400 Oakwood Road
Lake Zurich, IL 60047
1-800-432-3246
www.echo-usa.com
E-mail: echo-usa.custhelp.com/app/ask